

# INSTRUCTION MANUAL

## MW160 MAX pH / mV / ISE / Temperature Bench Meter





**THANK YOU for choosing Milwaukee Instruments!**

**This instruction manual will provide you the necessary information for correct use of the meter.**

*All rights are reserved. Reproduction in whole or in part is prohibited without the written consent of the copyright owner, Milwaukee Instruments Inc., Rocky Mount, NC 27804 USA.*

## TABLE OF CONTENTS

1. PRELIMINARY EXAMINATION .....	5
2. INSTRUMENT OVERVIEW .....	6
3. SPECIFICATIONS .....	7
4. FUNCTIONAL DESCRIPTION .....	9
5. PROBE DESCRIPTION .....	12
6. GENERAL OPERATIONS.....	14
6.1. POWER CONNECTION & BATTERY MANAGEMENT .....	14
6.2. MOUNTING THE ELECTRODE HOLDER .....	14
6.3. CONNECTING THE PROBES .....	15
6.4. ELECTRODE CARE & MAINTENANCE.....	16
7. SETUP .....	18
8. pH .....	20
8.1. PREPARATION .....	20
8.2. CALIBRATION .....	20
8.3. MEASUREMENT .....	22
8.4. WARNINGS & MESSAGES.....	23
9. ORP .....	24
9.1. PREPARATION .....	24
9.2. CALIBRATION .....	24
9.3. MEASUREMENT.....	25
9.4. WARNINGS & MESSAGES.....	26
10. ISE.....	27
10.1. PREPARATION .....	27
10.2. CALIBRATION .....	27
10.3. MEASUREMENT.....	29
10.4. WARNINGS & MESSAGES.....	29
11. LOGGING.....	30
12. GOOD LABORATORY PRACTICE (GLP).....	34

---

13. PC CONNECTION.....	37
13.1. USING MI5200 PC APPLICATION.....	37
13.2. SENDING COMMANDS FROM PC.....	37
14. TROUBLESHOOTING.....	39
15. ACCESSORIES.....	40
CERTIFICATION.....	41
RECOMMENDATION.....	41
WARRANTY.....	42

## 1. PRELIMINARY EXAMINATION

Each bench meter is delivered in a cardboard box and is supplied with:

- **MA917B/1** Double junction refillable pH electrode
- **MA831R** Stainless steel temperature probe
- **M10004** pH 4.01 buffer solution (sachet)
- **M10007** pH 7.01 buffer solution (sachet)
- **M10010** pH 10.01 buffer solution (sachet)
- **M10016** Electrode cleaning solution (sachet)
- **MA9315** Electrode holder
- **MA9350** RS232 connector cable (2 m)
- Graduated pipette
- 12 VDC adapter
- Instrument quality certificate
- Instruction manual

## 2. INSTRUMENT OVERVIEW

**MW160** is a compact and versatile bench meter that can measure up to four different parameters — pH, ORP, ISE (directly in ppm) and temperature.

The main operating modes are setup, calibration, measurement and logging.

pH calibration can be performed in up to 3 points (using a selection of 7 standard calibration buffers), to improve measurement reliability, even when testing samples with wide differences in pH.

ISE calibration can be performed in up to 2 points with 6 standard solutions available.

The meter can store up to 50 data sets for each range (pH, ORP, ISE) that can be downloaded to a PC via RS232 or USB.

Other features include:

- Easy to read LCD display
- Relative mV feature
- Internal clock and date to keep track of different time-dependent functions (calibration timestamp, calibration time-out)
- User-selectable time-out alarm to alert the user that too much time elapsed since the last pH calibration
- GLP feature to recall last calibration data for pH and ISE

For accurate measurements use the electrode holder supplied with the meter.

### 3. SPECIFICATIONS

Range	pH	-2.00 to 16.00 pH
	ORP	±699.9 mV / ±2000 mV
	ISE	0.001 to 19999 ppm
	Temp.	-20.0 to 120.0 °C (-4.0 to 248.0 °F)
Resolution	pH	0.01 pH
	ORP	0.1 mV / 1 mV
	ISE	0.001 (0.001 to 9.999) ppm
		0.01 (10.00 to 99.99) ppm
		0.1 (100.0 to 999.9) ppm
1 (1000 to 19999) ppm		
Temp.	0.1 °C / 0.1 °F	
Accuracy (@ 20 °C / 68 °F)	pH	±0.01 pH
	ORP	±0.2 mV / ±1 mV
	ISE	±0.5% F.S.
	Temp.	±0.4 °C / ±0.8 °F
Rel mV offset		±2000 mV
pH calibration	up to 3-point calibration, with 7 memorized buffers: pH 1.68, 4.01, 6.86, 7.01, 9.18, 10.01 and 12.45	
ISE calibration	1 or 2 points calibration, 6 standard solutions available: 0.01, 0.1, 1, 10, 100, 1000 ppm	
Temperature compensation	ATC – automatic, from -20.0 to 120.0 °C (-4.0 to 248.0 °F) MTC – manual, without temperature probe	
Logging memory	Up to 50 records for each measurement range (pH, ORP, ISE)	
Power supply	12 VDC adapter (included)	
PC connectivity	USB port and RS232 interface	
Environment	0 to 50 °C (32 to 122 °F); maximum RH 95%	
Dimensions	230 x 160 x 95 mm (9.0 x 6.3 x 3.7")	
Weight	1.1 kg (2.4 lb.)	

## Probe Specifications

pH electrode <b>MA917B/1</b>	pH range	0 to 14 pH
	Temperature range	0 to 70 °C (32 to 158 °F)
	Operating temperature	20 to 40 °C (68 to 104 °F)
	Reference electrolyte	KCl 3.5M
	Reference junction	Ceramic, single
	Reference type	Double, Ag/AgCl
	Maximum pressure	0.1 bar
	Body	Glass; tip shape: sphere
	Connector	BNC
	Dimensions	Shaft length: 120 mm (5.5"); Ø 12 mm (0.5")
	Cable length	1 m (3.2 ft)
Temperature probe <b>MA831R</b>	Temperature sensor	NTC10K
	Body	Stainless steel
	Connector	RCA
	Dimensions	Total length: 190 mm (7.5") Active part: 120 mm (5.5"); Ø 3,6 mm (1.4")
	Cable length	1 m (3.2 ft)



## 4. FUNCTIONAL DESCRIPTION

### Front Panel

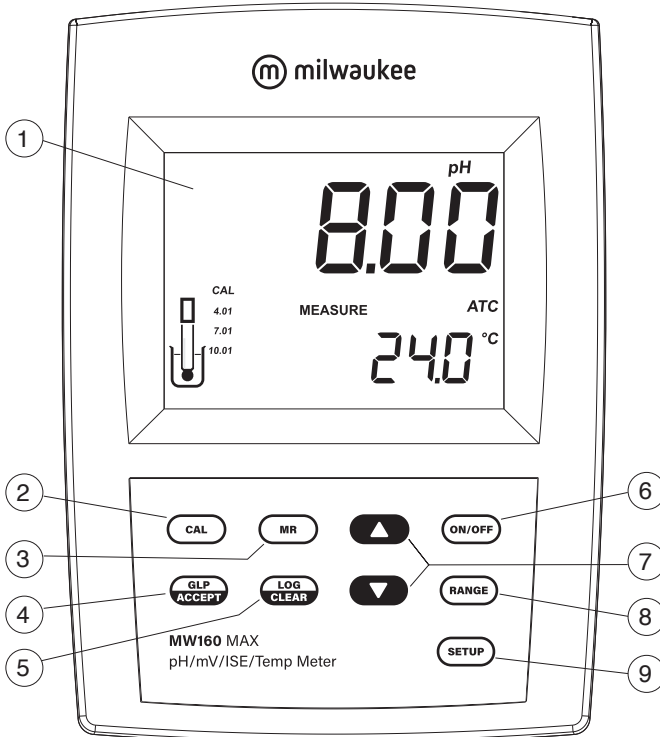

1. Liquid Crystal Display (LCD)
2. CAL key, to enter / exit Calibration mode
3. MR key, to enter / exit Memory Recall mode
4. GLP/ACCEPT key, to enter GLP or to confirm selected action
5. LOG/CLR key, to log the reading or to clear calibration or logging
6. ON/OFF key
7. ▲▼ directional keys, to navigate the menu, to modify parameter values, or to select calibration solutions or logged data
8. RANGE key, to select measurement range or to switch focused data
9. SETUP key, to enter / exit Setup mode; in Logging mode to toggle between delete one and delete all logged data

## Rear Panel

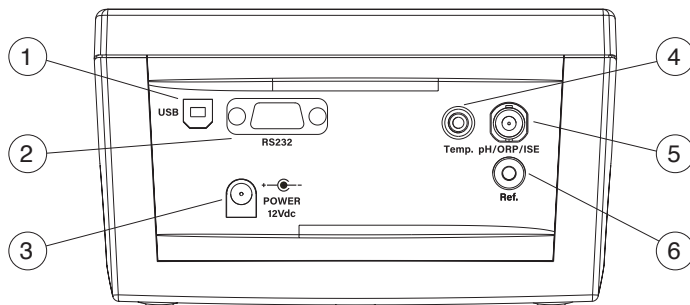

1. USB socket
2. RS232 socket
3. Power supply socket
4. RCA connector for temperature probe
5. BNC electrode connector
6. Reference electrode connector

Display Description

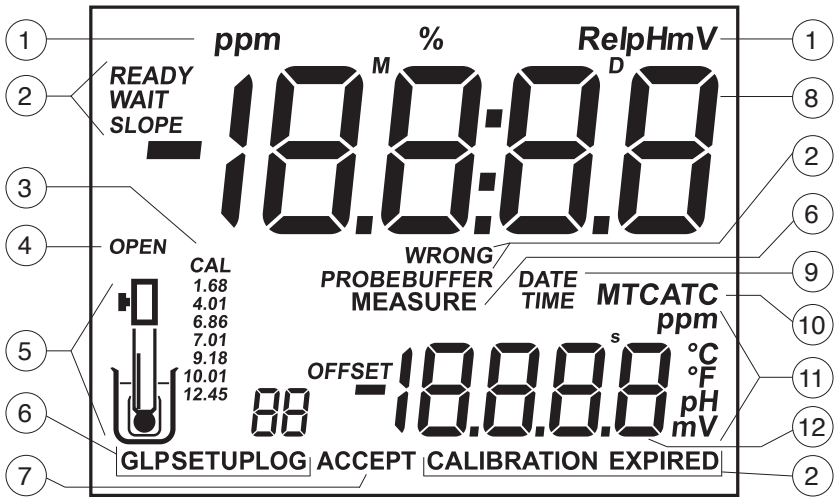

1. Measurement units
2. Status and calibration information
3. CAL tag and pH calibration buffers
4. OPEN tag
5. Probe symbol
6. Mode tags (GLP, SETUP, LOG, MEASURE)
7. ACCEPT tag
8. First LCD line, measurement readings
9. DATE and TIME tags
10. Temperature compensation status (MTC, ATC)
11. Measurement units for second LCD line
12. Second LCD line

## 5. PROBE DESCRIPTION

**MA917B/1** for pH measurement:

- Double junction design, reduces risk of clogging with the reference cell physically separated from the intermediate electrolyte.
- Refillable, with **MA9011** 3.5M KCl. This solution is silver free. Silver can cause silver precipitate to form at the junction resulting in clogging. Clogging causes erratic and slow readings. The ability to refill the electrolyte also extends the life of the electrode.
- Glass body, is easily cleaned and resistant to chemicals.
- Round tip, provides the largest possible surface area for faster readings and is well suited to testing liquid samples.

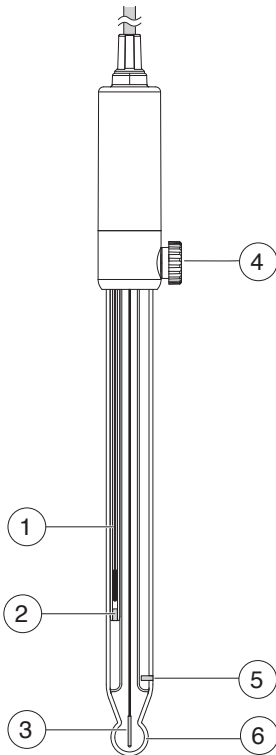

1. Reference wire
2. Inner reference junction
3. Sensing wire
4. Reference refill cap
5. Outer reference junction
6. Glass bulb

**MA831R** for temperature measurement and automatic temperature compensation (ATC):

- Made of stainless steel for corrosion resistance.
- Used in conjunction with the pH electrode to utilize the instrument's ATC capability.

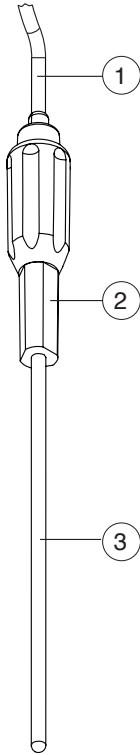

1. Cable
2. Handle
3. Stainless steel tube

## 6. GENERAL OPERATIONS

### 6.1. POWER CONNECTION & BATTERY MANAGEMENT

MW160 can be powered from the supplied 12 VDC adapter. The auto-off feature turns the meter off after 20 minutes of non-use.

At power on the instrument performs an auto-diagnostic test. All LCD segments are displayed for a few seconds.

The instrument starts with the previously selected measurement range. The OPEN tag and the "■", "□" symbols are displayed blinking for a few seconds to remind the user to unscrew the electrode refilling cap and to remove the protective cap before taking measurements.

### 6.2. MOUNTING THE ELECTRODE HOLDER

- Take the **MA9315** electrode holder from the box.
- Identify the metal plate (4) with the integrated pin (5) and the screw (2).  
The plate may be attached to either sides of the meter, left (L) or right (R).
- Turn the meter over, with the display facing down.

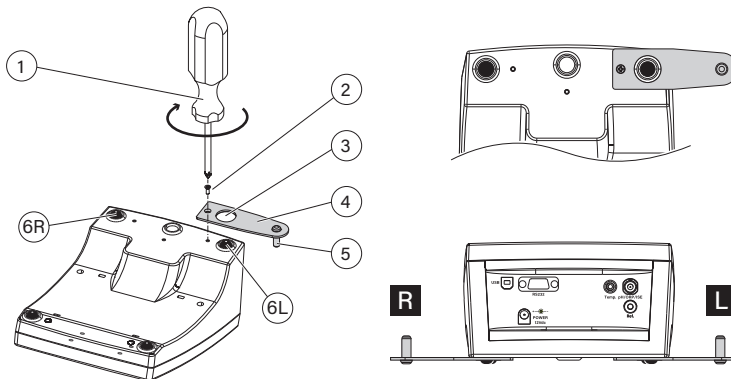

- Align the rubber foot (6R or 6L) with the hole (3) on the plate (4). Make sure the pin (5) is facing down.
- Use a screwdriver (1) to tighten the screw (2) and lock in place.

- Position the meter with the display facing up.
- Take the electrode holder (7) and insert it into the pin (5). The pin securely holds the electrode holder in place.
- For increased arm rigidity, tighten the metal knobs (8) on both sides.

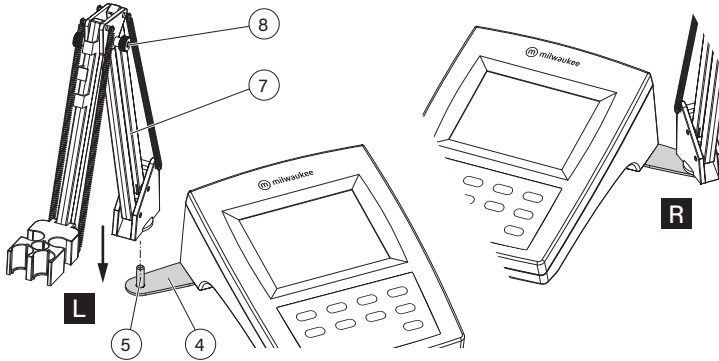

### 6.3. CONNECTING THE PROBES

#### MA917B/1 pH Probe

MA917B/1 is connected to the meter through a BNC connector (labeled pH/ORP).

With the meter off:

- Connect the probe to the BNC socket.
- Align and twist the plug into the socket.
- Place the probe into the holder and secure the cable in clips.

For electrodes with a separate reference, connect the electrode's BNC to the BNC connector and the reference electrode plug to the reference connector (labeled Ref.).

#### MA831R Temperature Probe

MA831R is connected to the meter through a RCA connector (labeled Temp.).

With the meter off:

- Connect the probe to the RCA socket.
- Push the plug into the socket.
- Place the probe into the holder and secure the cable in clips.

## 6.4. ELECTRODE CARE & MAINTENANCE

### Calibrating & Conditioning

Maintaining a pH electrode is critical to ensure proper and reliable measurements. Frequent two- or three-point calibrations are recommended to ensure accurate and repeatable results.

Prior to using the electrode for the first time:

1. Remove the protective cap. Do not be alarmed if salt deposits are present, this is normal. Rinse the electrode with distilled or deionized water.
2. Place the electrode in a beaker containing **MA9016** Cleaning solution for a minimum of 30 minutes.

**Note:** *Do not condition a pH electrode in distilled or deionized water as this will damage the glass membrane.*

3. For refillable electrodes, if the refill solution (electrolyte) has dropped more than 2 ½ cm (1") below the fill hole, add the appropriate electrolyte solution.
4. After conditioning, rinse the sensor with distilled or deionized water.

**Note:** *To ensure quick response and avoid cross-contamination, rinse the electrode tip with the solution to be tested before measurement.*

Best practices when handling an electrode:

- Electrodes should always be rinsed between samples with distilled or deionized water.
- Do not wipe an electrode as wiping can cause erroneous readings due to static charges.
- Blot the end of the electrode with lint-free paper.

### Storage

To minimize clogging and ensure quick response time, the glass bulb and the junction should be kept hydrated.

Add a few drops of **MA9015** Storage solution to the protective cap. Replace the storage cap when the probe is not in use.

**Note:** *Never store the probe in distilled or deionized water.*

### Regular Maintenance

- Inspect the probe. If cracked, replace the probe.
- Inspect the cable. Cable and insulation must be intact.
- Connectors should be clean and dry.
- Rinse off salt deposits with water.
- Follow storage recommendations.



For refillable electrodes:

- Refill the electrode with fresh electrolyte solution (see the electrode's specifications to select the correct refilling solution).
- Keep the electrode upright for 1 hour.
- Follow the storage procedure above.

If electrodes are not maintained correctly, both accuracy and precision are affected. This can be observed as a steady decrease in the slope of the electrode.

The slope (%) indicates the sensitivity of the glass membrane, the offset value (mV) indicates the age of electrode and provides an estimation when the probe needs to be changed. The slope percentage is referenced to the ideal slope value at 25 °C.

Milwaukee Instruments recommends that the offset does not exceed  $\pm 30$  mV and that the slope percentage is between 85–105%.

When the slope value drops below 50 mV per decade (85% slope efficiency) or the offset at the zero point exceeds  $\pm 30$  mV, reconditioning may improve performance, but a change of electrode may be necessary to ensure accurate pH measurements.

## 7. SETUP

To configure the meter settings, modify default values or set measurement parameters:

- Press and hold SETUP for about 3 seconds to enter Setup mode.
- Use the ▲▼ keys to navigate the menu (view parameters).
- Press CAL to enter Edit mode (modify parameters). The selected item is displayed blinking.
- Press RANGE to select between options.

For example, when setting current time, pressing RANGE switches between options (hour, minutes) to be modified.

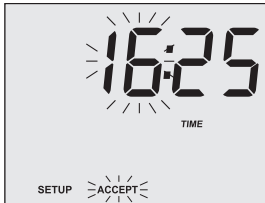

- Use the ▲▼ keys to modify values (value being modified is displayed blinking).
- Press GLP/ACCEPT to confirm and save changes (ACCEPT tag is displayed blinking).
- Press CAL to exit Edit mode without saving (return to menu).
- Press SETUP to exit Setup mode.

The Setup menu items with options and default values are detailed here:

Item	Description	Options	Default
<b>OFF DAY</b>	<b>Calibration alarm time-out (pH range only)</b> When enabled, a warning will be displayed after the set number of days from last calibration has elapsed.	1 to 14 days or OFF	OFF
<b>DISP</b>	<b>Display calibration buffers (pH range only)</b> When enabled, the buffers used in the last calibration are displayed on the pH measurement screen.	ON or OFF	ON
<b>IonCG</b>	<b>Ion charge (ISE range only)</b> Use the following table to select the proper ion charge.	-2, -1, 1, 2 or UndF	UndF
<b>TIME</b>	<b>Current time</b> in hh:mm format	00:00 to 23:59	00:00

Item	Description	Options	Default
<b>DATE</b>	<b>Current date</b> in MM.DD.YYYY format	01.01.2000 to 12.31.2099	01.01.2005
<b>bBEEP</b>	<b>Beep status</b> When enabled, an acoustic signal is heard every time a key is pressed.	ON or OFF	OFF
<b>bAud</b>	<b>Baud rate</b> for serial communication	600, 1200, 2400, 4800 or 9600	2400
<b>In Id</b>	<b>Instrument ID</b> When using several identical meters, it may be useful to uniquely identify them by assigning a code to each meter.	0000 to 9999	0000
<b>tEMP</b>	<b>Temperature unit</b>	°C or °F	°C

To help select the proper ion charge, different ion types and their charge are listed in the table below:

Ion Charge	Ion Types
-2 (divalent anions)	S, CO <sub>3</sub>
-1 (monovalent anions)	F, Cl, Br, I, CN, SCN, ClO <sub>4</sub> , NO <sub>3</sub>
1 (monovalent cations)	H, Na, K, Ag, NH <sub>4</sub>
2 (divalent cations)	Mg, Ca, Ba, Cd, Cu, Pb
UndF	Undefined ion

## 8. pH

### 8.1. PREPARATION

Up to three-point calibration can be performed with a choice of 7 standard buffers (1.68, 4.01, 6.86, 7.01, 9.18, 10.01 and 12.45 pH).

1. Prepare two clean beakers. One beaker is for rinsing and one for calibration.
2. Pour small quantities of the selected buffer solution into each beaker.
3. Remove the protective cap and rinse the probe with buffer solution used for the first calibration point.

If necessary, press RANGE until the display changes to pH measurement range.

### 8.2. CALIBRATION

#### General Guidelines

For better accuracy, frequent calibrations are recommended. The probe should be recalibrated at least once a week, or:

- whenever is replaced
- after testing aggressive samples
- when high accuracy is required
- when the calibration time out has expired

#### Procedure

1. Immerse the pH and the temperature probes approximately 4 cm (1 ½") into the buffer solution and stir gently. Make sure the temperature probe is positioned close to the pH probe.
2. Press CAL. The CAL, BUFFER, CALIBRATION tags, the buffer number and the buffer value (7.01) are displayed along with WAIT tag blinking. If needed, press the ▲▼ keys to select a different buffer value.

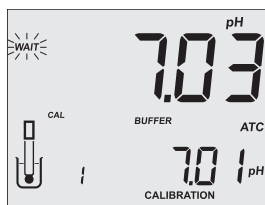

3. When the reading is stable and close to the selected buffer, READY and ACCEPT tags are displayed blinking. Press GLP/ACCEPT to confirm calibration.

The calibrated value is displayed in the first LCD line, the second expected buffer value in the second LCD line. The tag of the buffer already calibrated is listed under the CAL tag.

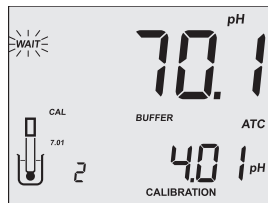
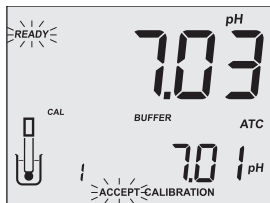

For one-point calibration, press CAL to exit calibration. The instrument stores the calibration and returns to Measurement mode.

To continue calibrating with additional buffers, rinse and place the pH and temperature probes tip approximately 4 cm (1½") into the next buffer solution and stir gently. Make sure the temperature probe is positioned close to the pH probe.

If needed, press the ▲▼ keys to select a different buffer value.

**Note:** The instrument automatically skips the buffers already used for the previous calibration points to avoid erroneous procedure.

Press RANGE to display the temperature reading during calibration.

### Clear Calibration

1. Press CAL to enter Calibration mode.
2. Press LOG/CLR. "CLr CAL" is displayed shortly, then the instrument returns to Measurement mode.

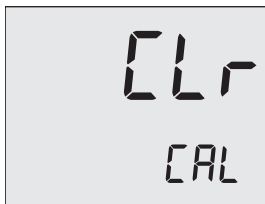

### 8.3. MEASUREMENT

Make sure the instrument has been calibrated before taking pH measurements.

1. Remove the probe protective cap and place the tip approximately 4 cm (1 ½") into the sample. It is recommended to wait for the sample and the pH probe to reach the same temperature.
2. If necessary, press RANGE until the display changes to pH measurement range. Allow the reading to stabilize (blinking WAIT tag disappears).

The LCD will display:

- measurement and temperature readings
- temperature compensation mode (MTC or ATC)
- buffers used (if option enabled in Setup)

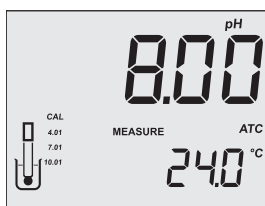

For best results is recommended to:

- Calibrate the probe before use and recalibrate periodically.
- Keep the electrode hydrated.
- Rinse the probe with the sample before use.
- Soak in **MA9015** Storage solution for at least 1 hour before measurement.

#### MTC mode

If Manual Temperature Compensation (MTC) is desired, the temperature probe must be disconnected from the instrument.

The LCD displays the default temperature of 25 °C or the last temperature reading with the blinking MTC and °C (or °F) tags.

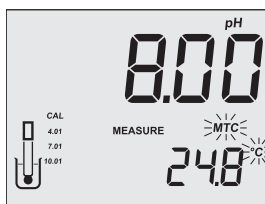

The temperature can be adjusted using the ▲▼ keys (from -20.0 °C to 120.0 °C).

## 8.4. WARNINGS & MESSAGES

- "CALIBRATION EXPIRED" message is displayed when the meter is not calibrated or the set calibration time-out has elapsed.
- "WRONG BUFFER WRONG PROBE" message is displayed blinking during calibration when the difference between the pH reading and selected buffer value is significant. Check if correct calibration buffer has been used. Condition the probe following the description in ELECTRODE CARE & MAINTENANCE section. If necessary, change the buffer or the probe.
- "WRONG BUFFER" and "Old" messages are displayed blinking during calibration when an inconsistency between new and previous (old) calibration is detected. Clear calibration parameters by pressing LOG/CLR and proceed with calibration from the current calibration point (the instrument keeps all confirmed values during current calibration).
- "WRONG BUFFER" message and blinking temperature value are displayed during calibration when buffer temperature is out of range. The calibration cannot be confirmed. Use fresh buffers for calibration.
- When the measured value is out of range, the closest full-scale value is displayed blinking in the first LCD line. Recalibrate the meter. Check if the sample is within measurable range.

## 9. ORP

### 9.1. PREPARATION

For accurate ORP measurements, the surface of the electrode must be clean and smooth. Pretreatment solutions are available to condition the electrode and improve its response time (see ACCESSORIES section).

**Note:** For direct ORP measurements use an ORP probe. MA9020 ORP Solution can be used to confirm that the ORP sensor measures correctly. mV readings are not temperature compensated.

If necessary, press RANGE until the display changes to ORP measurement range.

### 9.2. CALIBRATION

#### mV Calibration

The MW160 is factory calibrated for mV.

Milwaukee's ORP electrodes are interchangeable and no mV calibration is needed when they are replaced.

If the mV measurements are inaccurate, mV recalibration should be performed. For an accurate recalibration contact Milwaukee Technical Service.

#### Relative mV Calibration

**Note:** When a Rel mV calibration is performed, the range changes from mV to Rel mV.

1. Immerse the probe approximately 4 cm (1½") into the standard solution and stir gently.
2. Press CAL. The CALIBRATION tag appears on the LCD, the relative mV value is displayed in the first LCD line and the absolute mV value in the second LCD line. The WAIT tag is displayed blinking until the reading is stable.

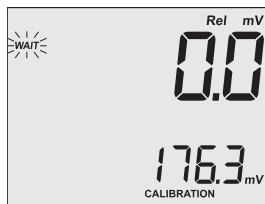



- When the absolute reading is stable and in the measurement range, the READY and ACCEPT tags are displayed blinking.

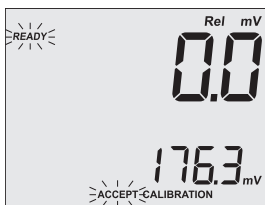

- Press GLP/ACCEPT to confirm the calibration. The instrument returns to Measurement mode, Rel mV range.

### Clear Calibration

To return to mV measurement range, clear the Rel mV calibration.

- Press CAL to enter Calibration mode.
- Press LOG/CLR. The "CLr CAL" message appears on the LCD for one second then the instrument enters to mV measurement range.

### 9.3. MEASUREMENT

If necessary, press RANGE until the display changes to ORP measurement range.

**Note:** If the instrument displays a Rel mV reading and mV measurements are needed, clear the Rel mV calibration (see Relative mV Calibration section).

Remove the probe protective cap and immerse the tip approximately 4 cm (1 1/2") into the sample. Allow the reading to stabilize (blinking WAIT tag disappears).

The instrument displays the mV reading in the first LCD line (or Rel mV reading if a Rel mV calibration has been performed) and the temperature of the sample in the second LCD line.

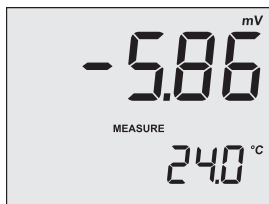

or

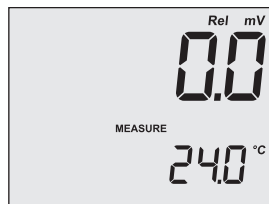

#### 9.4. WARNINGS & MESSAGES

- When the reading is out of range during a Rel mV calibration, the absolute mV value and "WRONG" are displayed blinking.  
Check if correct standard solution has been used. Refresh the probe following the description in ELECTRODE CARE & MAINTENANCE section  
If necessary, change the standard solution or the probe.
- When the reading is out of range during measurement, the closest full-scale value is displayed blinking.  
Recalibrate the meter.  
Check if the sample is within measurable range.

## 10. ISE

### 10.1. PREPARATION

One or two-point calibration can be performed with a choice of 6 standard solutions (0.01, 0.1, 1, 10, 100 and 1000 ppm).

1. In Setup menu select the proper ion charge (see SETUP section for details).

**Note:** When "UndF" option is selected, a two-point calibration must be performed. If exiting calibration after first standard is confirmed, the LCD displays "----".

2. Prepare two clean beakers. One beaker is for rinsing and one for calibration.
3. Pour small quantities of standard solution into each beaker.
4. Remove the protective cap and rinse the probe with solution used for the first calibration point.

If necessary, press RANGE until the display changes to ISE measurement range.

### 10.2. CALIBRATION

For better accuracy frequent calibrations are recommended. The ISE range should be recalibrated at least once a week, or:

- whenever the ISE probe or ion charge is changed
- after testing aggressive samples
- when high accuracy is required

Due to electrode conditioning time, the electrode must be kept immersed a few seconds to stabilize.

#### Procedure

1. Immerse the probe approximately 4 cm (1 ½") into the selected solution and stir gently.
2. Press CAL. The CAL, BUFFER, CALIBRATION tags, the calibration point number and the standard value (0.010) are displayed along with WAIT tag blinking. If needed, press the ▲▼ keys to select a different standard.

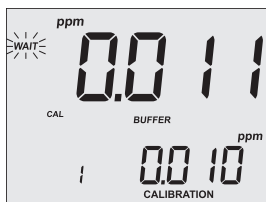

3. When the reading is stable and close to the selected standard, the READY and ACCEPT tags are displayed blinking. Press GLP/ACCEPT to confirm calibration.

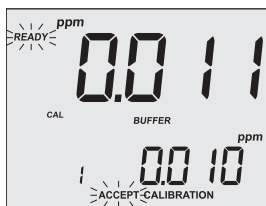

For one-point calibration, press CAL to exit calibration. The instrument stores the calibration and returns to Measurement mode.

To continue calibrating, rinse and place the probe tip approximately 4 cm (1½") into the next solution and stir gently. If needed, press the ▲▼ keys to select a different value.

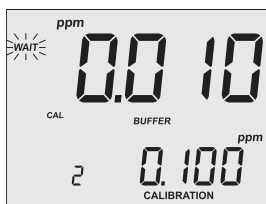

**Note:** The instrument will automatically skip the standard used for the first point.

Press RANGE to display temperature reading during calibration.

### Notes:

The slope window is within  $\pm 20$  mV and  $\pm 105$  mV if ion charge is not specified (UndF option in Setup menu), or between 50% and 120% of default slope for the corresponding ion charge.

Default slope values (mV/decade):

- 59.16 (monovalent anion) - ion charge is -1
- 59.16 (monovalent cation) - ion charge is 1
- 29.58 (divalent anion) - ion charge is -2
- 29.58 (divalent cation) - ion charge is 2
- 100 - ion charge is "UndF"

If a one-point calibration is performed after a two-point calibration, the instrument keeps the old slope.

## Clear Calibration

1. Press CAL to enter Calibration mode.
2. Press LOG/CLR. "Clr CAL" is displayed shortly, then the instrument returns to Measurement mode.

## 10.3. MEASUREMENT

If necessary, press RANGE until the display changes to ISE measurement range.

Remove the probe protective cap and immerse the tip of the probe 4 cm (1½") into the sample. Allow the reading to stabilize (blinking WAIT tag disappears).

The instrument displays the ppm reading in the first LCD line and the temperature in the second LCD line.

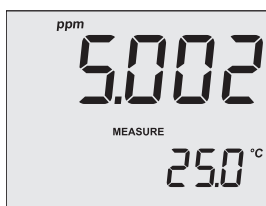

## 10.4. WARNINGS & MESSAGES

- "WRONG BUFFER WRONG PROBE" message is displayed blinking during calibration when the new slope is out of the slope window.  
Check if correct standard solution has been used. Refresh the probe following the description in ELECTRODE CARE & MAINTENANCE section.  
If necessary, change the standard solution or the probe.
- When the measured value is out of range, the closest full-scale value is displayed blinking in the first LCD line.  
Recalibrate the meter.  
Check the sample is within measurable range.

## 11. LOGGING

The instrument can memorize up to 50 log records for each measurement range (pH, ORP and ISE).

### Logging Current Data

1. Press RANGE from the measurement screen and select required measurement range.
2. Press LOG/CLR to log the current measurement.

The LOG tag, current date (MM.DD), the record number and the number of free log space are displayed for a few seconds, then the instrument returns to Measurement mode.

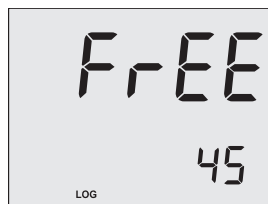

### Viewing & Deleting Logged Data

1. Press RANGE to select required measurement range.
2. Press MR fto enter Memory Recall mode.

The first LCD line displays the pH, Rel mV or ppm value. The LOG tag and the last stored record number are displayed.

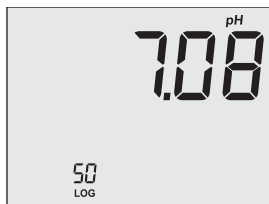

OR

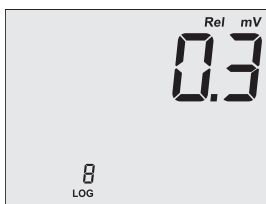

OR

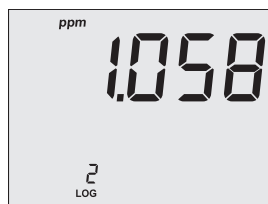

3. Press the ▲▼ keys to view different records in the current measurement range:

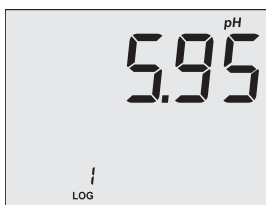

A complete set of information is stored along with the measured value. Press RANGE to view the parameters:

- The mV value in the first LCD line and the temperature in the second LCD line.

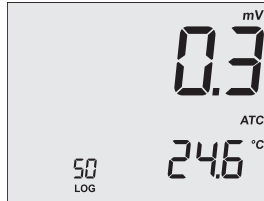

- The date: month and day in the first LCD line and the year in the second LCD line. DATE tag is displayed.



- The time: hour and minutes in the first LCD line and the seconds in the second LCD line. TIME tag is displayed.



- The slope in the first LCD line and the offset in the second LCD line. SLOPE and OFFSET tags are displayed.

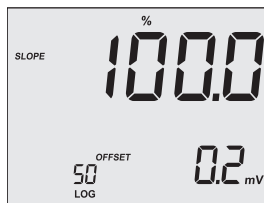

**Note:** Dashes are displayed for slope in Rel mV range and for offset in ISE range.

- The "dEL" message in the first LCD line and the record number in the second LCD line. ACCEPT tag is displayed blinking.

**To delete logged data:**

- Press the ▲ or ▼ key to select next or previous record to be deleted.
- Press SETUP to toggle between the record number and "ALL" option. "dEL ALL" option selects all records to be deleted for the current range.

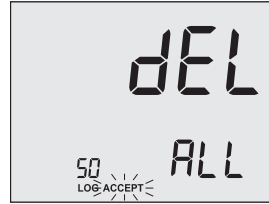
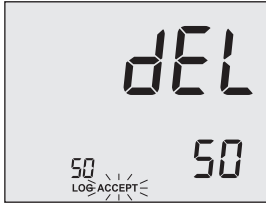

- Press GLP/ACCEPT to delete the selected or all records. "nuLL" message is displayed for the deleted record or the instrument returns to Measurement mode if all records were deleted.

Press MR to exit Memory Recall mode at any time.

**Warnings & Messages**

- Blinking "Lo" message and the record number are displayed when less than 6 free log spaces are available.



- "FULL LOC" message is displayed when no free log space available.





- If MR is pressed and no logged data are stored, "no rEC" message is displayed blinking for the selected measurement range.

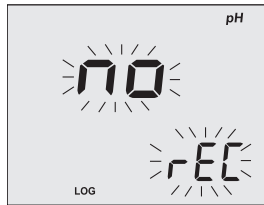

## 12. GOOD LABORATORY PRACTICE (GLP)

GLP allows the user to store and recall calibration data and probe status. Correlating readings with specific calibrations ensures uniformity and consistency.

pH and ISE calibration data is stored automatically after a successful calibration.

1. Press RANGE to select required measurement range.
2. Press GLP/ACCEPT to view GLP data.
3. Use the ▲▼ keys to scroll through the displayed parameters.
4. Press GLP/ACCEPT to return to Measurement mode.

If the instrument has not been calibrated for the selected range, "no CAL" message is displayed blinking.

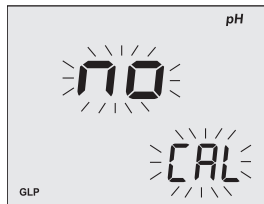

### pH Information

- Time (hh:mm:ss) of the last calibration



- Date (MM.DD.YYYY) of the last calibration



- The slope value in the first LCD line and the offset in the second LCD line

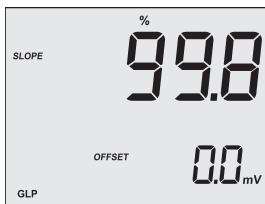

- The pH calibration buffers on consecutive LCDs in calibrating order

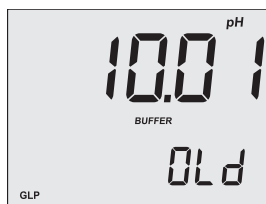
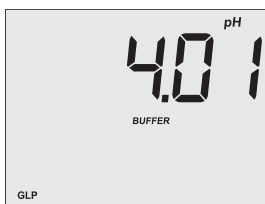
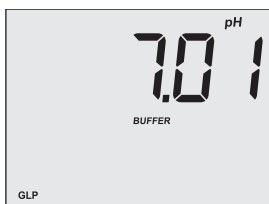

**Notes:**

*"0Ld" message is displayed beneath the pH value when the buffer was not used during last calibration. Press SETUP to see calibration date and time.*

*"no BUFFER" message is displayed when the calibration was performed in less than three points.*

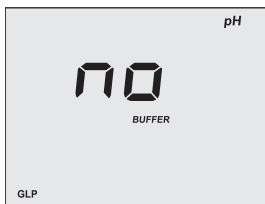

- Number of days until the calibration alarm will be displayed (e.g. 5 days, -3 days if the time has expired) or "OFF" if the function has been disabled in Setup

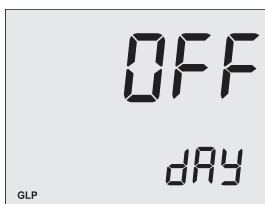

- The instrument identification code



**ISE Information**

- Date (MM.DD.YYYY) of the last calibration
- The slope value in the first LCD line and the offset in the second LCD line

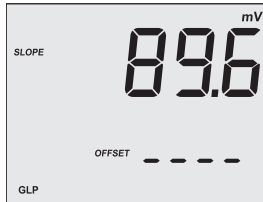

- The calibration standards in calibration order

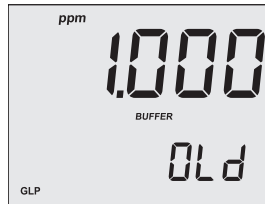
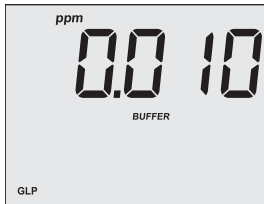

- The instrument identification code

**Notes:**

*“0Ld” message is displayed beneath the ppm value when the standard was not used during last calibration. Press SETUP to see calibration date and time.*

*“no BUFFER” message is displayed when only a one-point calibration was performed.*

*If a one-point calibration is performed after a two-point calibration, the instrument keeps the old slope.*

## 13. PC CONNECTION

### 13.1. USING MI5200 PC APPLICATION

The logged data can be transferred to a PC via the Milwaukee Instruments **MI5200** Windows<sup>®</sup> compatible application using the RS232 or USB serial interface.

The software is available for download at <http://www.milwaukeeinst.com>. Search for the product code and click on it. After download is complete, use the exe file to install the software.

**MI5200** offers graphing and on-line help feature. Data can be exported to well-known spreadsheet programs for further analysis.

1. Switch the meter off.
2. Connect the instrument to a PC with the supplied **MA9350** cable (if using the RS232 port) or with a standard USB cable.
3. Start the application.

#### **Notes:**

*For RS232 other cables than MA9350 may use a different configuration and communication between instrument and PC may not be possible.*

*Keep only one cable connected (RS232 or USB) during PC communication to avoid possible errors.*

### 13.2. SENDING COMMANDS FROM PC

It is also possible to remotely control the instrument with any terminal program.

1. Switch the meter off.
2. Use the **MA9350** cable to connect the instrument to a PC.
3. Start the terminal program and set the communication options as follows: 8, N, 1, no flow control.

#### **Command Types**

To send a command to the instrument follow the next scheme:

<\*> <command> <CR>

where: <\*> is the command prefix,

<command> is the command code.

**Note:** *Either small or capital letters can be used.*

#### **Unit Change Command**

**CHU xx** Changes the instrument unit according with the parameter value (xx):

- xx=01 pH range / 0.01 resolution
- xx=03 mV / Rel mV range
- xx=05 ppm range

The instrument will answer for this command with:

<STX> <answer> <ETX>

where: <STX> is 02 ASCII code character (start of text)

<ETX> is 03 ASCII code character (end of text)

<answer>:

<ACK> is sent for a recognized command

<CAN> is sent when the instrument is logging

<Err6>/<Err8> is sent when the command is incorrect or the instrument is not in Measurement mode.

### Commands Requiring an Answer

The instrument will answer for these commands with:

<STX> <answer> <checksum> <ETX>

where the checksum is the bytes sum of the answer string sent as 2 ASCII characters.

All the answer messages are with ASCII characters.

- RPH** Causes the instrument to send a complete set of readings according with the pH range.
- RMV** Causes the instrument to send a complete set of readings according with the mV/Rel mV range.
- RIS** Causes the instrument to send a complete set of readings according with the ISE range.
- MDL** Requests the instrument model name and firmware code (16 ASCII chars).
- INF** Requests the calibration data and the setup parameters.
- SAM** Requests the number of logged samples (12 chars).
- LDPH** Requests the xxx<sup>th</sup> pH record logged data.
- LDMV** Requests the xxx<sup>th</sup> mV/Rel mV record logged data.
- LDIS** Requests the xxx<sup>th</sup> ISE record logged data.
- LAPH** Requests all pH Log on demand.
- LAMV** Requests all mV/Rel mV Log on demand.
- LAIS** Requests all ISE Log on demand.

#### **Notes:**

*"Err8" is sent if the instrument is not in Measurement mode.*

*"Err6" is sent if the requested range is not available.*

*"Err4" is sent if the requested set parameter is not available.*

*"Err3" is sent if the Log on demand is empty.*

*Invalid commands will be ignored.*

## 14. TROUBLESHOOTING

Symptom	Problem	Solution
Slow reponse / Excessive drift	Dirty pH electrode	Soak the electrode tip in <b>MA9016</b> cleaning solution for 30 minutes and then follow the Cleaning procedure.
Reading fluctuates up and down (noise)	Clogged/dirty junction. Low electrolyte level (refillable electrodes only)	Clean the electrode. Refill with fresh <b>MA9012</b> electrolyte.
Display shows the full scale value blinking	Reading out of range	Recalibrate the meter. Check the sample is within measurable range. Check if electrolyte level and general electrode status.
mV scale out of range	Dry membrane or dry junction	Soak the electrode in <b>MA9015</b> storage solution for at least 30 minutes.
Display shows the temperature unit blinking	Out of order temperature probe	Replace the temperature probe.
Meter fails to calibrate or gives faulty readings	Broken probe	Replace the probe.
LCD tags displayed continuously at startup	One of the keys is blocked	Check the keyboard. If the error persists, contact Milwaukee Technical Service.
"Er0, Er1, Er2" message at start up	Internal error	Restart the meter. If error persists, contact Milwaukee Technical Service.

## 15. ACCESSORIES

<b>SE-300</b>	Double junction ORP platinum probe
<b>MA917B/1</b>	Combination pH electrode, glass body, refillable
<b>MA924B/1</b>	ORP probe, glass body, refillable
<b>MA831R</b>	Stainless steel temperature probe
<b>MA9001</b>	pH 1.68 buffer solution (230 mL)
<b>MA9004</b>	pH 4.01 buffer solution (230 mL)
<b>MA9006</b>	pH 6.86 buffer solution (230 mL)
<b>MA9007</b>	pH 7.01 buffer solution (230 mL)
<b>MA9009</b>	pH 9.18 buffer solution (230 mL)
<b>MA9010</b>	pH 10.01 buffer solution (230 mL)
<b>MA9012</b>	Refilling solution for pH electrode (230 mL)
<b>MA9015</b>	Storage solution (230 mL bottle)
<b>MA9016</b>	Electrode cleaning solution (230 mL)
<b>MA9020</b>	200-275 mV ORP solution (230 mL)
<b>MA9112</b>	pH 12.45 buffer solution (230 mL)
<b>MA9310</b>	12 VDC adapter, 220 V
<b>MA9311</b>	12 VDC adapter, 110 V
<b>MA9315</b>	Electrode holder
<b>MA9350</b>	RS232 connection cable (2 m)



## CERTIFICATION

Milwaukee Instruments conform to the CE European Directives.



**Disposal of Electrical & Electronic Equipment.** Do not treat this product as household waste. Hand it over to the appropriate collection point for the recycling of electrical and electronic equipment.

Please note: proper product disposal prevents potential negative consequences for human health and the environment. For detailed information, contact your local household waste disposal service or go to **[www.milwaukeeinstruments.com](http://www.milwaukeeinstruments.com)** (US only) or **[www.milwaukeeinst.com](http://www.milwaukeeinst.com)**.

## RECOMMENDATION

Before using this product, make sure it is entirely suitable for your specific application and for the environment in which it is used. Any modification introduced by the user to the supplied equipment may compromise the meter's performance. For your and the meter's safety do not use or store the meter in hazardous environment. To avoid damage or burn, do not perform any measurement in microwave ovens.

## **WARRANTY**

This instrument is warranted against defects in materials and manufacturing for a period of 3 years from the date of purchase. Electrodes and Probes are warranted for 6 months. This warranty is limited to repair or free of charge replacement if the instrument cannot be repaired. Damage due to accidents, misuse, tampering or lack of prescribed maintenance is not covered by warranty. If service is required, contact your local Milwaukee Instruments Technical Service. If the repair is not covered by the warranty, you will be notified of the charges incurred. When shipping any meter, make sure it is properly packaged for complete protection.

*Milwaukee Instruments reserves the right to make improvements in design, construction and appearance of its products without advance notice.*

**THANK YOU FOR CHOOSING**



Sales and Technical Service Contacts:

Milwaukee Electronics Kft.  
Alsó-kikötő sor 11C  
H-6726 Szeged - HUNGARY  
tel: +36 62 428 050  
fax: +36 62 428 051  
[www.milwaukeeinst.com](http://www.milwaukeeinst.com)  
e-mail: [sales@milwaukeeinst.com](mailto:sales@milwaukeeinst.com)

Milwaukee Instruments, Inc.  
2950 Business Park Drive  
Rocky Mount, NC 27804 USA  
tel: +1 (252) 443-3630  
fax: +1 (252) 443-1937  
[www.milwaukeeinstruments.com](http://www.milwaukeeinstruments.com)  
e-mail: [sales@milwaukeeinstruments.com](mailto:sales@milwaukeeinstruments.com)