

Coating Thickness GAUGE
INSTRUCTION MANUAL



Version: WT2100-EN-00

A. Introduction

This product is a color-screen portable coating thickness gauge with high-definition display. It can quickly, non-destructively and accurately measure the thickness of non-magnetic coating (such as paint, electroplate, thin film, etc.) on magnetic metal substrates. It is widely used in manufacturing, metal processing, chemical industry, commodity inspection and other testing areas.

B. Functions



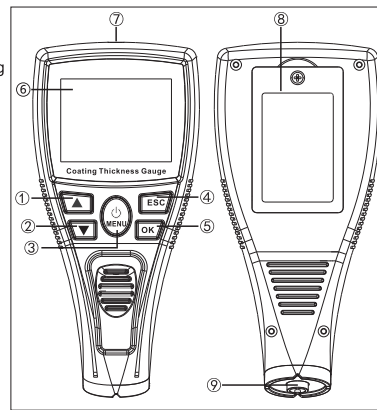

- ▶ Menu operation and color-screen HD display.
- ▶ Non-magnetic coating thickness measurement on magnetic metal substrate surface.
- ▶ Two measurement methods: single measurement, continuous measurement.
- ▶ Three calibration modes: basic, offset, zero calibration.
- ▶ Metric/imperial unit and storage function.
- ▶ Screen rotation, charge protection, multi-interface displays, screen brightness selection.
- ▶ Automatic shutdown.

C. Name of Parts

- ① Up button: switch measurement modes/ increase calibration data
- ② Down button: switch measurement units and reduce calibration data
- ③ Menu and On/Off
- ④ Return
- ⑤ Confirm
- ⑥ LCD display
- ⑦ USB charging interface
- ⑧ Battery door
- ⑨ Test probe



D. Description of charging function

1. Battery life indicator "  "
2. Normal charging "  "
3. Charging complete "  "
4. Charging without battery "  "
5. During charging, the product has temperature protection, with protection range 3 °C ~ 45 °C or so. If the temperature is out of protection range,  will show up and charging will be stopped.
6. If charging temperature exceeds the protection range during shutdown, the meter screen will light up for 1 second every 10 seconds.

Warning: The charging function is only for rechargeable batteries. Disposable batteries is prohibited from charging!

E. Measurement Interface Instruction

1. Measurement Instruction: After turning on the instrument, lightly press the test probe on the tested substrate under measurement interface. The measured value is the thickness of coating on the substrate.
2. Measured Values:
 - a. The title bar shows the title and battery state of the interface.
 - b. Yellow number is the measured thickness.
 - c. Num is the times of measurement.
 - d. SNG is the selected measurement mode (SNG is single measurement and CTN is continuous measurement).
 - e. Fe on the upper right is the measured substrate (Fe is for magnetic metal substrate).
 - f. The green icon on the lower right is measurement unit.
3. Measured values and trend chart:
 - a. The trend chart below is the trend of the last 20 groups of data.
 - b. The trend chart shows the high and low limit values.
4. Measured Values and Statistics:
 - a. Dif : Difference value compared to the last measurement
 - b. Avg: Average value
 - c. Max: Maximum value
 - d. Min: Minimum value
 - e. High: High limit
 - f. Low: Low limit
 - g. Sdev: standard deviation

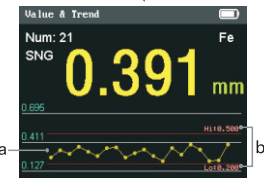

- h. CV%: coefficient of variation
Note: The standard deviation and coefficient of variation are calculated for the last 100 measured data.
5. Measured values vs. past values view:
 - a. This interface shows the last 12 measured data.
6. Measured Values and Bar Graph:
 - a. The bar graph shows the proportion of the measured value in the measurement range.
 - b. The bar chart shows the high and low limits.
 - c. The measured data forms up green bar graph in the range of high and low limit values.
 - d. The measured data from up red bar graph when exceeding high and low limits.

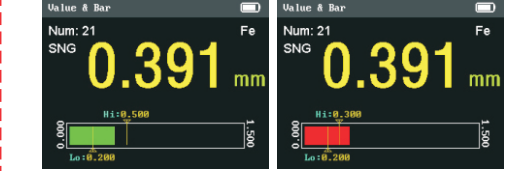
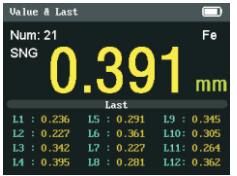

F. Calibration Operation

1. Basic calibration:
 - a. Prepare the calibration plate and calibration base, enter calibration menu and select basic calibration.
 - b. According to the instrument instruction, place the corresponding calibration plate for calibration.
 - c. After calibration is completed, "calibration complete" will show up at the bottom of the screen and the instrument will return to the previous interface.
 - d. After the calibration is complete, you can go back to measurement interface and perform measurement.
2. Offset Calibration:
 - a. Enter calibration menu and select Offset Calibration.
 - b. Measure the thickness of single point by following the instruction at the bottom of the screen.
 - c. Pick up the instrument and press Up/Down button to adjust the value.
 - d. Press OK when the adjustment is completed. "Calibration complete" will show up at the bottom of the screen and the instrument will return to the previous interface.
 - e. After the calibration is complete, you can go back to measurement interface and perform measurements.
3. Zero Calibration:
 - a. Enter calibration menu and select zero calibration.

- b. Press the instrument lightly on the substrate as instruction at the bottom of the screen.
 - c. The instrument will automatically calibrate to zero point.
 - d. "Calibration complete" will show up at the bottom of the screen and the instrument will return to the previous interface.
 - e. After calibration is complete, you can go back to measurement interface and perform measurements.
- Note: If the measured value turns to silver gray after zero calibration, the measured value is negative. If 0.241mm is calibrated to zero, the measured value will be displayed as silver gray when the original zero point is measured again.

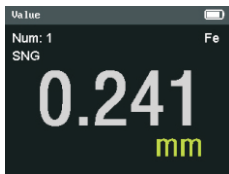

- c. In the lower part of histogram displays icon of data, and the set high and low alarm values are in the middle.
 - d. The data column above or below alarm value is red.
 - e. The black line and data at the top are the interval of histogram.
3. Storage space:
 - a. The storage space is divided into 100 storage areas. Each storage area can store up to 15 data.
 - b. Storage with less than 15 data will occupy one storage area, and data storage with more than 15 data and less than 100 data will occupy multiple storage areas.

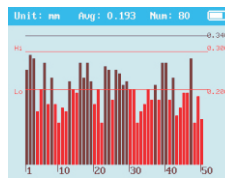

I. Measurement View

1. Press Up/Down button under measurement interface to switch measurement view.
2. If a measurement view is set to be closed, this view is skipped when you press Up/Down button under measurement interface.
3. If measurement view options are all off, the instrument automatically opens measurement view options.

J. Settings

1. Screen rotation under measurement: after startup, the screen will only rotate under the measurement interface.
2. Restore factory settings: restore default settings and clear calibration data.

K. Technical Parameters

Measurement range	0~1800um/0~70.9mil
Resolution	(0.1µm(<100µm), 1µm(≥100µm))/ 0.1mil/0.001mm
Measurement error	≤150µm ±5µm >150µm ±(3%H+1µm)
Minimum diameter of magnetic metal substrate	12mm
Minimum thickness of magnetic metal substrate	0.5mm
Minimum radius of curvature for magnetic convex substrate	2mm
Minimum radius of curvature for magnetic concave substrate	11mm
Battery	3x1.2V NiMH battery (weight 36.5g) or 5V1A power adapter
Size	70.30*38.6*149.59mm
Weight	136.9(including battery)

L. Menu Chart

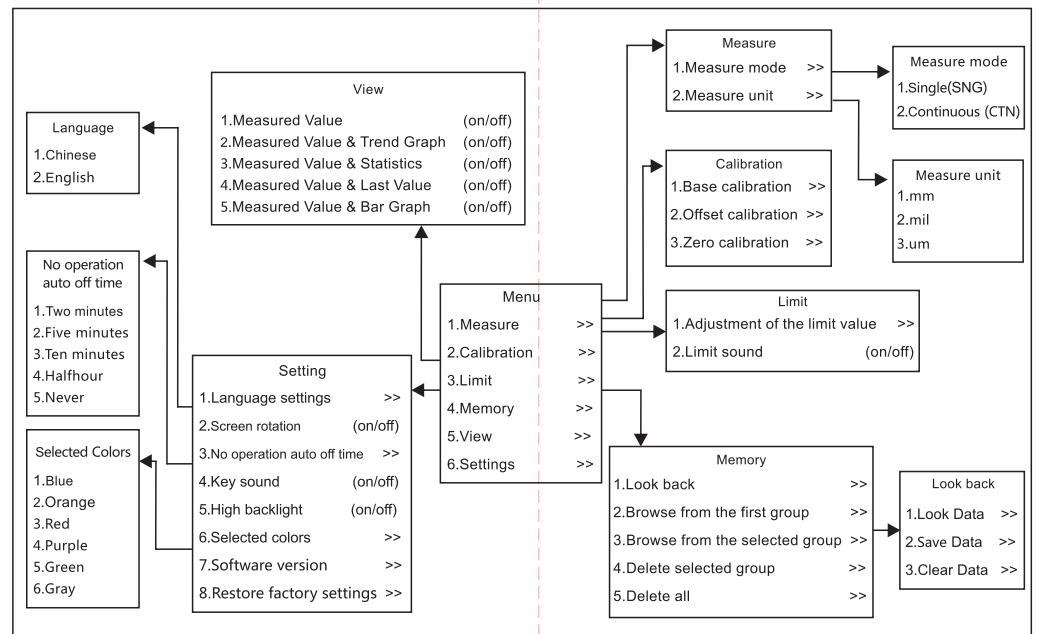

M. Attention

1. Keep the probe away from the measured substrate when starting up.
2. After startup, ERR1 or ERR2 indicates probe error.
3. After startup, ERR1 or ERR2 indicates substrate error.
4. During measurement, "----" indicates that the substrate is not calibrated.
5. During measurement, "-OL-" indicates data overflow.

TIPS: This device is equipped with rechargeable battery. If you receive the product and cannot start up, please connect with the adapter for charging before use.

Specific Declarations:
Our company shall hold no any responsibility resulting from using output from this product as an direct or indirect evidence. We reserves the right to modify product design and specification without notice.



G. Calibration Operations

1. Enter limit value interface to select limit value adjustment.
2. Adjust high limit value according to the screen instruction.
3. Short press Up/Down button to or long press Up/Down button to adjust high limit value.
4. After adjusting high limit value, press OK button and then start adjusting low limit value.
5. Short press Up/Down button to adjust low limit value or long press Up/Down button to adjust low limit value.
6. After adjustment is complete, press OK button to go back to previous interface.

H. Storage Management

1. Review:
 - a. Press OK button under measurement interface to enter into review menu.
 - b. Choose Check function under Review menu to view the last measured 100 data.
 - c. Choose Save function under Review menu to save the measured data (the last 100 data).
 - d. Select Clear function under Review menu to clear the measured data.

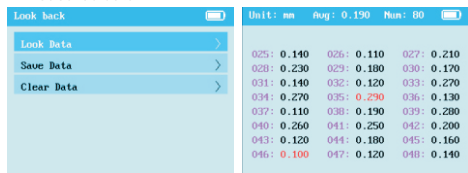

2. Data browsing:
 - a. The title bar of browsing interface displays selected unit, average value, and the number of saved data.
 - b. The maximum and minimum values of saved data are marked in red.