

MASTECH®

MS2125B

DUAL DISPLAY DIGITAL CLAMP METER OPERATION MANUAL

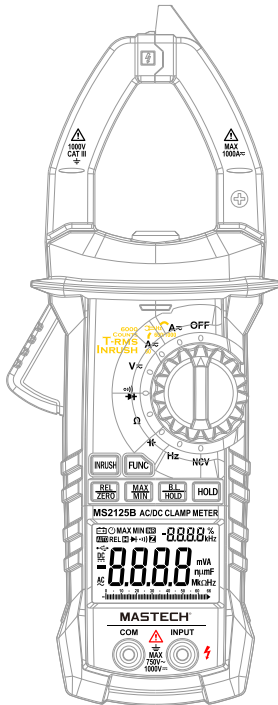

CAT IV
600V

CAT III
1000V

CE

ETL
c Us
Intertek

CONTENTS

1. Safety Information	1
1.1 Preparation.....	1
1.2 Usage	2
1.3 Mark.....	3
1.4 Maintenance	4
2. Description	4
2.1 Part Name	5
2.2 Switch and Button Description	7
2.3 LCD Display	7
3. Specification	9
3.1 General.....	9
3.2 Technique Data.....	10
4. Operating Guidance	16
4.1 Reading Hold.....	16
4.2 Measuring Range Switch.....	16
4.3 Back Light and Clamp Head Light.....	16
4.4 Maximum/Minimum Measurement Choice	17
4.5 Function Choice	17

CONTENTS

4.6 Relative Measurement	17
4.7 Surge Measurement	18
4.8 Automatic Power-Off	18
4.9 Measurement Preparation	18
4.10 Current Measurement	19
4.11 Voltage Measurement	20
4.12 Frequency And Duty Ratio Measurement	20
4.13 Resistance Measurement	21
4.14 Diode Test	21
4.15 Circuit Continuity Test	22
4.16 Capacitance Measurement	22
4.17 Surge Current Measurement	22
4.18 Non-Contact Voltage Detection	23
4.19 USB Communication	24
5. Maintenance	24
5.1 Replace Battery	24
5.2 Replace Probe	25
6. Attachments	25

1. Safety Information

WARNING

Be extremely careful when using this meter. Improper use of this device can result in electric shock or destruction of the meter. Take all normal safety precautions and follow the safeguards suggested in this manual. To exploit full functionality of the meter and ensure safe operation, please read carefully and follow the directions in this manual. If the equipment is used in a manner not specified by the manufacturer, the protection provided by the equipment may be impaired.

This meter is designed and manufactured according to safety requirements of EN 61010-1, EN 61010-2-032, EN 61010-2-033 concerning electronic measuring instruments with a measurement CAT III 1000V, CAT IV 600V and pollution degree 2 and safety requirements for hand-held clamps for electrical measurement and test.

1.1 Preparation

- 1.1.1 When using the meter, the user should comply with standard safety rules for:
 - General shock protection
 - Proper use of the meter
- 1.1.2 Please check for damage caused during transportation after receiving the meter.
- 1.1.3 If the meter is stored and shipped under hard conditions, please confirm that the meter operates properly or is damaged.
- 1.1.4 Probe should be in good condition. Before use, please check whether the probe insulation is damaged and whether the metal wire is bare.
- 1.1.5 Use the probe table provided with the meter to

ensure safety. If necessary, replaced the probe with another identical probe or one with the same specification.











1.2 Usage

- 1.2.1 When using the meter, select the right function and measuring range.
- 1.2.2 Don't make measurements that exceed indicated values in each measuring range.
- 1.2.3 When measuring circuits with the meter connected, do not contact with probe tip (metal part).
- 1.2.4 If voltage to be measured is more than 60V DC or 30V AC (RMS), always keep your fingers behind finger protection device.
- 1.2.5 Do not measure voltage greater than AC 750V.
- 1.2.6 When selecting the manual measuring range, if you don't know the value to be measured, choose the highest measuring range and decrease gradually until the correct range is displayed.
- 1.2.7 Before rotating selection switch to change measuring function, remove probe from the circuit to be measured.
- 1.2.8 Don't measure resistors, capacitors, diodes and circuit connections with power.
- 1.2.9 During tests of current, resistors, capacitors, diodes and circuit connections, avoid connecting the meter to voltage source.
- 1.2.10 Do not measure capacitance before capacitor is discharged completely.
- 1.2.11 Do not use the meter in explosive gas, vapor or dusty environment.
- 1.2.13 Do not use the meter unless the meter bottom case and the battery cover are completely

fastened in original places.

- 1.2.14 Don't store or use the meter in direct sunlight, high temperature and high humidity.

1.3 Symbols

	Note-Important safety information, refer to the instruction manual.
	Application around and removal from UNINSULATED HAZARDOUS LIVE conductors is permitted.
	Caution, possibility of electric shock
	Equipment protected throughout by double insulation or reinforced insulation.
	Conforms to UL STD. 61010-1, 61010-2-032, 61010-2-033; Certified to CSA STD C22.2 NO. 61010-1, 61010-2-032, 61010-2-033
	Complies with European (EU) safety standards
	Earth (ground) TERMINAL
	Direct current
	Alternating current
	Both direct and alternating current
CAT III	It is applicable to test and measuring circuits connected to the distribution part of the building's low-voltage MAINS installation.
CAT IV	It is applicable to test and measuring circuits connected at the source of the building's low-voltage MAINS installation.

1.4 Maintenance

- 1.4.1 Don't try to open the meter bottom case to adjust or repair. Such operations only can be made by technicians who fully understand the meter and electrical shock hazard.
- 1.4.2 Before opening the meter bottom case or battery cover, remove probe from the circuit to be measured.
- 1.4.3 To avoid incorrect readings and possible electric shock, when " " appears on the meter display, replace the battery immediately.
- 1.4.4 Clean the meter with damp cloth and mild detergent. Do not use abrasives or solvents.
- 1.4.5 Turn power off when the meter is not used, and switch the measuring range to OFF position.
- 1.4.6 If the meter is not used for long time, remove the battery to prevent damage to the meter.

2. Description

- The meter is a portable, professional measuring instrument with LCD display and back light for easy reading by users. Measuring range switch is operated by single hand for easy operation. The meter has overload protection and a low battery indicator. It is an ideal multifunction meter for professionals, factories, schools, fans and family use.
- The meter is used for measuring AC current, DC current, voltage, DC voltage, frequency, duty ratio, resistance, capacitance measurement and circuit connection, diode test and non-contact voltage detection.
- The meter has automatic measuring range and manual measuring range.
- The meter has reading hold function.

- The meter has max. measuring function.
- The meter has min. measuring function.
- The meter has clamp head frequency measurement function.
- The meter has auto power-off function.
- The meter has relative measuring function.

2.1 Part Name

- (1) Non-contact voltage detection sensing area
- (2) Current clamp head: used for current measurement.
- (3) Clamp head light
- (4) Rotary switch
- (5) Input Socket
- (6) NCV indicator
- (7) Trigger
- (8) Key
- (9) Display
- (10) Common socket
- (11) USB Communication socket

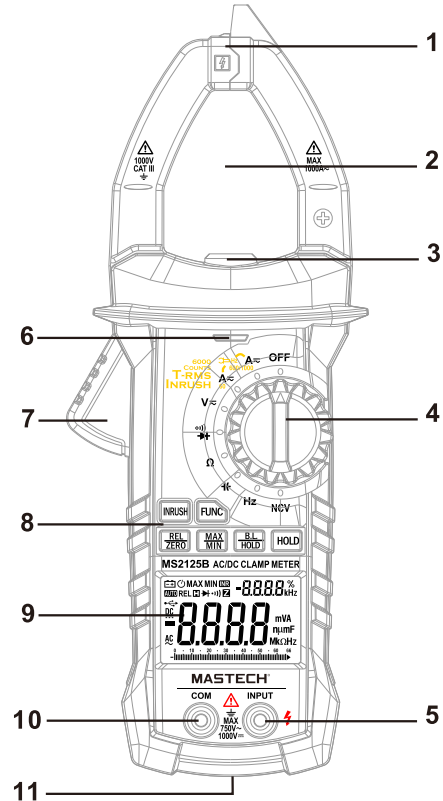

2.2 Rotary Switch, Button And Input Jack Description

B.L/RANGE button: used for measuring range switch or back light control.

FUNC button: used for measuring function switch.

HOLD button: data hold.

REL/ZERO button: Used for entering relative measurement state (when making non-DC current measurement), DC current zeroing function (DC current measurement).

INRUSH button: Surge current measurement.

MAX/MIN button: used for maximum/minimum measurement function switch.

Rotary switch: used for shutting off power or function selection.

INPUT jack: voltage, resistance, frequency, duty ratio, capacitance, diode, circuit connection input wire connecting terminal.

COM jack: voltage, resistance, frequency, duty ratio, capacitance, diode, circuit connection common wire connecting terminal.

2.3 LCD Display



AC, DC	Alternating Current, direct current
▶ ◀)	Diode, on/off
AUTO	Automatic measuring range mode
MAX /MIN	Maximum/minimum measurement
INR	Surge current test
REL	Relative measurement mode
⏻	Automatic power-off indicator
Z	DC current zeroing function
🔋	LOW BATTERY
H	Reading hold state
%	Percentage (duty ratio)
mV,V,A	Millivolt, Volt (voltage), Ampere (current)
nF,μF,mF	Nano farad, Microfarad, Millifarad
Ω,kΩ,MΩ	Ohm, Kilohm, Megohm (resistance)
Hz,kHz,MHz	Hertz, Kilohertz, Megahertz (frequency)
NCV	Non-contact voltage detection
🔄	USB communication indicator

3. Specifications

Each year, at a minimum, the meter should be recalibrated when temperature is 18°C ~ 28°C and relative humidity is less than 75%.

3.1 General

- Automatic measuring range and manual measuring range.
- Full measuring range overload protection.
- The maximum allowable voltage between measurement end and ground: 1000V DC or 750V AC
- Operational height: maximum 2000m
- Display: LCD
- Displayed maximum value: 6000 digit.
- Polarity indication: automatic indication, '-' means negative polarity.
- Exceeding measuring range display: 'OL' or '-OL'.
- Sampling rate: about 4 times/sec.
- Unit display: has function and power unit display.
- Auto off time: 15 min
- Power supply: DC power 9V
- Battery type: NEDA 1604, 6F22
- Battery low voltage indication: LCD displays  symbol.
- Temperature coefficient: less than 0.1×accuracy/°C
- Operational temperature: 18°C ~ 28°C
- Storage temperature: -10°C ~ 50°C
- Dimension: 238×92×50mm
- Weight: about 420g (including battery)

3.2 Technical Indicators

3.2.1 True RMS Zero Input Characteristic

- 3.2.1.1 For measuring non-sinusoidal wave signals, use the true RMS measuring method, which has less error than the traditional average response measuring method.
- 3.2.1.2 The true RMS meter can accurately measure non-sinusoidal wave signals, but in AC function, when there is no signal to be measured (input terminal short circuit in AC voltage grade), the clamp meter may show a reading from 1 to 50. These deviating readings are normal. In the designated measurement range, they will not affect the meter's accuracy.
- 3.2.1.3 True RMS can be measured only when input signal reaches a certain level. Therefore, measuring range of AC voltage and current should be specified at 2%~100% of full range.

3.2.2 AC Current

Measuring range	Resolution	Accuracy
60A	0.01A	±(2.5% reading + 8 digits)
600A	0.1A	
1000A	1A	

- Maximum input current: 1000AAC
- Frequency range: 50 ~ 60Hz;

3.2.3 DC Current

Measuring range	Resolution	Accuracy
60A	0.01A	±(2.5% reading + 8 digits)
600A	0.1A	
1000A	1A	

- Maximum input current: 1000A DC

3.2.4 Surge Current

Measuring range	Resolution	Accuracy
60A	0.01A	< 60A for reference only ±(10% reading + 60 digits)
600A	0.1A	
1000A	1A	

Time of integration: 100ms; measurement range: 10~1000A; frequency range: 40~400Hz

3.2.5 DC Voltage

Measuring range	Resolution	Accuracy
600mV	0.1mV	±(0.5% reading + 5 digits)
6V	0.001V	
60V	0.01V	
600V	0.1V	
1000V	1V	±(0.8% reading + 4 digits)

- Input impedance: 10MΩ
- Maximum input voltage: 750V AC (RMS) or 1000V DC
- 600mV measuring range can be inputted only by RANGE key.

Note:

In the small voltage measuring range, the probe is not connected with the circuit to be tested, and the meter may have fluctuating readings, This is normal and caused by the meter's high sensitivity, and does not affect actual measurement results.

3.2.6 AC Voltage

Measuring range	Resolution	Accuracy
600mV	0.1mV	±(0.8% reading + 5 digits)
6V	0.001V	
60V	0.01V	
600V	0.1V	
750V	1V	±(0.8% reading + 4 digits)

- Input impedance: 10MΩ
- Maximum input voltage: 750V AC (RMS) or 1000V DC
- Frequency range: 50 ~ 60Hz
- 600mV measuring range can be inputted only by RANGE key.

Note:

In the small voltage measuring range, the probe is not connected with the circuit to be tested, and the meter may have fluctuating readings, This is normal and caused by the meter's high sensitivity. This does not affect the actual measurement results.

3.2.7 Frequency

3.2.7.1 Clamp head measuring frequency (through grade A):

Measuring range	Resolution	Accuracy
60.00Hz	0.01Hz	±(1.5% reading + 5 digits)
600.0Hz	0.1Hz	
1.000kHz	1Hz	

- Measuring scope: 10Hz~1kHz
- The input signal range: ≥ 20AAC (RMS) (input current will increase when the frequency to be measured increases)

3.2.7.2 Through grade V:

Measuring range	Resolution	Accuracy
60.00Hz	0.01Hz	±(1.5% reading + 5 digits)
600.0Hz	0.1Hz	
6.000kHz	1Hz	
10.00kHz	10Hz	

- Measuring scope: 10Hz~10kHz
- The input voltage range: > 20mV AC (RMS) (input voltage will increase when the frequency to be measured increases)

3.2.7.3 Through Hz grade:

Measuring range	Resolution	Accuracy
60.00Hz	0.01Hz	±(0.3% reading + 5 digits)
600.0Hz	0.1Hz	
6.000kHz	1Hz	
60.00kHz	0.01kHz	
600.0kHz	0.1kHz	
6.000MHz	1kHz	
60.00MHz	0.01MHz	

- The input signal: VPP 3V square wave; Overload protection: 250V DC or AC (RMS)

3.2.8 Duty Ratio

Measuring range	Resolution	Accuracy
10-90%	0.1%	±3.0%

3.2.9 Resistance

Measuring range	Resolution	Accuracy
600Ω	0.1Ω	±(0.8% reading + 3 digits)
6kΩ	0.001kΩ	
60kΩ	0.01kΩ	
600kΩ	0.1kΩ	
6MΩ	0.001MΩ	±(1.2% reading + 3 digits)
60MΩ	0.1MΩ	

- Overload protection: 250V DC or AC (RMS)

3.2.10 Circuit Continuity Test

Measuring range	Resolution	Function
	0.1Ω	If the resistance of circuit to be measured is less than 50Ω, the meter's built-in buzzer may sound.

- Overload protection: 250V DC or AC (RMS)

3.2.11 Capacitance

Measuring range	Resolution	Accuracy	
6.000nF	0.001nF	±(6% reading + 5 digits)	
60.00nF	0.01nF		
600.0nF	0.1nF		
6.000μF	0.001μF		
60.00μF	0.01μF		±(3.0% reading + 5 digits)
600.0μF	0.1μF		
6.000mF	0.001mF		
60.00mF	0.01mF		

- Overload protection: 250V DC or AC (RMS)

3.2.12 Diode Test

Measuring range	Resolution	Function
	0.001V	Display approximate diode forward voltage value

- Forward DC current is about 1mA

- Overload protection: 250V DC or AC (RMS)

4. Operating Guidance

4.1 Reading Hold

In the process of measurement, if reading hold is required, then press “**HOLD**” key to release reading hold.

4.2 Manual Measuring Range

RANGE key is automatic/manual measuring range key to trigger mode. The preset function is automatic measuring range. Press to switch to manual measuring range. In the manual measuring range mode, click once to jump to upper grade, till to the top grade, then continue to press this key to jump back to automatic measuring range.

Note:

In the frequency measurement state, manual measuring range button is invalid.

4.3 Back Light and Clamp Head Light

- 1) In the process of measurement, if ambient light is too dark to read, press “**B.L/RANGE**” key about 2 seconds to turn on the backlight. The backlight will automatically turn off after about 10 seconds.
- 2) During this period, pressing “**B.L/ HOLD**” key more than two seconds will turn off backlight.
- 3) In the current grade, the meter will turn on backlight, and at the same time it will turn on clamp head light. Backlight luminophor is **LED** with high working current. Although the meter has no timing circuit, if backlight is used often, it will shorten battery life. Therefore, minimize use of the backlight to conserve battery power.

4.4 Maximum/Minimum Measurement Choice

- 1) Press "**MAX/MIN**" key to enter MAX mode and save measurement maximum value. Press "**MAX/MIN**" key again and the meter will enter minimum value measurement state and save minimum value;
- 2) After entering MAX or MIN mode, the meter will automatically save the measured maximum or minimum value.
- 3) When making maximum/minimum value measurement, the meter's main display is current measurement value. The alternate display shows maximum or minimum value.

Note:

- 1) When the meter is in the maximum/minimum value measurement state, it is manual measuring range mode.

4.5 Function Switch

- 1) In the resistance grade, press "**FUNC**" button to cycle among resistance, diode and continuity detection.
- 2) In the voltage and current grade, press "**FUNC**" button to switch between AC and DC.

4.6 REL/ZERO

- 1) **REL/ZERO** button is a relative value measurement button, operated by tapping the button to enter the relative value measurement mode. The current display value can be stored in memory as a reference value. When the user measures later, the display value is the difference for input value

minus reference value. ie. $REL\Delta(\text{current reading}) = \text{Input value} - \text{Reference value}$. The main display shows input value - reference value, and the alternate display shows reference value.

- 2) The relative value measurement only can be performed in the manual mode.

4.7 INRUSH Measurement

In the AC current measurement state, press **INRUSH** key to enter surge measurement state, then press **INRUSH** key again to quit surge measurement state.

4.8 Automatic Power-Off

- 1) If there is no operation for 10 minutes (5 minutes when measuring current) after turning the machine on, the meter will enter a suspended state, automatically powering off to save the batter. One minute before shutdown, the buzzer will sound five times. At shutdown, the buzzer will make one long sound and then the meter will turn off.
- 2) After automatic power-off, press any key, the meter will turn on.
- 3) Holding the "**INRUSH**" key when powering on will cancel the automatic power-off function.

4.9 Measurement Preparation

- 1) Turn the transfer switch to turn on the meter. When battery voltage is low (about $\leq 7.2V$), and the LCD displays "**⚡**" symbol. Replace the battery.
- 2) Place transfer switch to required measuring function and range.
- 4) When testing line voltage, connect the common test line first, then connect the charged test line. When removing line, please remove charged test line first.

4.10 Current Measurement

- 1) Rotary switch is placed to position A. At this time, the meter is in AC current measurement state. Choose appropriate measuring range. If you want to measure DC current, press **FUNC** button to enter direct current measurement state.
- 2) Hold the trigger, open clamp head, clip one lead of measurement circuit to be tested in the clamp.
- 3) When measuring AC current, the main display shows measured value, and the alternate display shows the frequency of the current to be measured.
- 4) Read the current value on the LCD display.

Note:

- 1) Clamping two or more leads of circuit to be tested simultaneously will not give correct measuring results.
- 2) To get accurate readings, connect the lead to be tested at the center of current clamp.
- 4) To improve the measurement precision, in the DC current measurement state, if the LCD display is not zero, press **ZERO** to return to zero, then measure.
- 5) When measuring current, be sure to switch the meter to DC or AC state first, then clamp the wire to be measured in the clamp. Otherwise, it will cause invalid readings.

4.11 Voltage Measurement

- 1) Insert black probe to **COM** jack, insert red probe to **INPUT** jack, choose appropriate measuring range.
- 2) Place transfer switch to AC voltage **V \approx** position. At this time, the meter is in the AC voltage measurement state. To measure DC voltage, press **FUNC** button to enter DC voltage measurement state.
- 3) To measure mV voltage, switch the meter to mV range through the **RANGE** key.
- 4) Connect the probe with voltage source or both ends of load in parallel for measurement.
- 5) Read the voltage on the LCD.

Note:

- 1) In the small voltage measuring range, the probe is not connected with the circuit to be tested, and the meter may have fluctuating readings. This is normal and caused by the meter's high sensitivity. When the meter is connected with the circuit to be tested, you will get actual measured value.

4.12 Frequency and Duty Ratio Measurement

- 1) Insert black probe to **COM** jack, insert red probe to **INPUT** jack.
- 2) Transfer switch is placed to position **HZ**.
- 3) Connect the probe with signal or both ends of load in parallel for measurement.

Note:

Frequency measurement range is 10Hz~60MHz. If the frequency to be tested is less than 10Hz, LCD will show "00.0". When measuring frequencies higher than 60MHz, duty ratio measurement accuracy is not guaranteed.

4.13 Resistance Test

- 1) Insert black probe to **COM** jack, insert red probe to **INPUT** jack.
- 2) Place measuring range switch to $\Omega \rightarrow$ position. At this time, the meter is in the measurement state.
- 3) Connect the probe to the both ends of resistor or circuit to be tested.
- 4) LCD will show readings.

Note:

- 1) When the input end is open, LCD shows "0L" out-of-range state.
- 2) When the resistance to be tested > 1M Ω , the meter reading will be stable after a few seconds, which is normal for high resistance readings.

4.14 Diode Test

- 1) Insert black probe to **COM** jack, insert red probe to **INPUT** jack.
- 2) Measuring switch is placed to position $\Omega \rightarrow$.
- 3) Press "**FUNC**" key to switch to \rightarrow measuring state.
- 4) Connect the red probe to diode anode and connect the black probe to diode cathode.
- 5) Read on the LCD.

Note:

- 1) What the meter shows is approximation of diode forward voltage drop.
- 2) If the probe has reverse connection or the probe is open, the LCD will show "0L".

4.15 Circuit Continuity Test

- 1) Insert black probe to **COM** jack, insert red probe to **INPUT** jack.
- 2) Measuring switch is placed to position $\Omega \rightarrow$.
- 3) Press "**FUNC**" key to switch to \rightarrow circuit continuity measuring state.
- 4) Connect the probe to the both ends of circuit to be tested.
- 5) If the resistance of circuit to be measured is less than 30 Ω , the meter's built-in buzzer may sound.
- 6) Read the circuit resistance value on the LCD.

Note:

If the probe is open or circuits resistance to be tested is more than 600 Ω , the display will show "0L".

4.16 Capacitance Measurement

- 1) Insert black probe to **COM** jack, insert red probe to **INPUT** jack.
- 2) Rotary switch is placed to position \rightarrow .
- 3) After discharging capacitance completely, connect the probe to the both ends of capacitor to be tested.
- 4) Read the capacitance on the LCD.

4.17 Surge Current Measurement

- 1) Place rotary switch to position A, press **FUNC** key to switch AC current measurement state.
- 2) Press "**INRUSH**" key to enter surge current measurement mode, at this time, LCD shows "- - -".
- 3) Hold the trigger, open clamp head, clip one lead of measurement circuit to be tested in the clamp.
- 4) When the meter detects surge current activation, the meter will show and keep surge current value.
- 5) Read the current value on the LCD display.

Note:

- 1) Clamping two or more leads of circuit to be tested simultaneously will not give correct readings.
- 2) To get accurate reading, connect the lead to be tested at the center of current clamp.
- 3) In the manual measuring range mode, when LCD only shows "OL", which indicates over-range, choose higher measuring range.
- 4) In the manual measuring range mode, if you don't know the size of value to be measured in advance, choose the highest measuring range, then decrease gradually until the correct range is displayed..

4.18 NCV Measurement

- 1) Turn the meter to NCV grade.
- 2) The meter shows "NCV" sign, the main display of meter shows - - - ; and the alternate display shows the current NCV detection sensitivity "SE-n" (number of n is from 0 to 9). The bigger digit is, the higher sensitivity will be. Press RANGE key to increase sensitivity, MAX/MIN key to reduce sensitivity. Press HOLD key to save the setting sensitivity.

Note:

- 1: Even there is no indication, voltage may exist still. Don't use non-contact voltage detector to test whether there is voltage in the wire. Detection operation could be affected by socket design, insulation thickness, type and other factors.
- 2: When inputting voltage on the meter input terminal, due to the existence of the induced voltage, voltage induction indicator also may light.

- 3: Interference sources of external environment (such as flashlight, motor, etc.) may trigger non-contact voltage detection by mistake.

4.19 USB Communication

- 1) Install MS2115B communication software and USB driver in the PC (see PC software operation manual in the attached CD for details).
- 2) Use USB cable to connect the meter and PC. At this time, the meter will displays , which means that it is sending data.
- 3) Open installed MS2115B communication software in the PC. Data measured by the meter can be uploaded to PC for further analysis.

5. Maintenance

5.1 Replace Battery

WARNING

To avoid electric shock, make sure that the test leads have been clearly move away from the circuit under measurement before opening the battery cover.

1. If the symbol "" appears, it means that the batteries should be replaced.
2. Loosen the screw of the battery cover and remove it.
3. Replace the used battery with a new one.
4. Return the battery cover and tighten the screw.

Note: The battery polarity can't be reversed.

5.2 Replace Probe

Replace test leads if leads become damaged or worn.



WARNING

Use meet EN 61010-031 standard, rated CAT III 1000V, or better test leads.



WARNING

To avoid electric shock, make sure the probes are disconnected from the measured circuit before removing the rear cover. Make sure the rear cover is tightly screwed before using the instrument.

6. Accessories

1)	Test Probe	1 pair
2)	Operating Manual	1 pcs
3)	9V DC battery (6FF2)	1 pcs
4)	USB communication cable	1 pcs
5)	Case	1 pcs
6)	MS2125B communication software CD	1 pcs

