

# MASTECH® MS2033A

## AC Digital Clamp Meter User's Manual

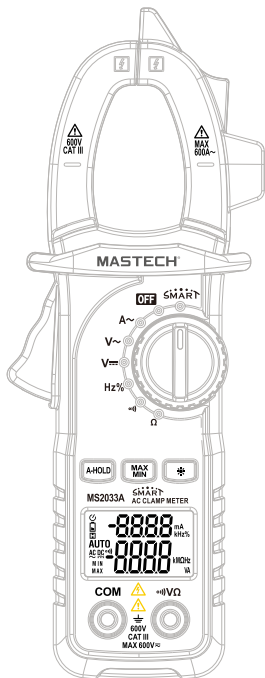

Intertek

# MASTECH®

## CONTENTS

1. Introduction .....	01
2. Safety Information .....	01
2.1 Precautions .....	02
2.2 Safety Symbols .....	03
3. Description .....	04
3.1 Front Panel .....	04
3.2 Display .....	06
4. Using the Meter .....	07
4.1 Data Auto .....	07
4.2 A-Hold .....	07
4.3 Auto Power Off .....	07
4.4 DC Voltage .....	07
4.5 AC Voltage .....	08
4.6 AC Current .....	08

## CONTENTS

4.7 Resistance .....	9
4.8 Continuity .....	9
4.9 Frequency/Duty Cycle .....	10
<b>5. Specifications .....</b>	<b>11</b>
5.1 General Specifications .....	11
5.2 Technical Specifications .....	12
<b>6. Maintenance .....</b>	<b>15</b>
6.1 General Maintenance .....	15
6.2 Replacing the Batteries .....	16
6.3 Replacing Test Leads .....	16
<b>7. Accessories .....</b>	<b>17</b>

## 1. Introduction

### WARNING

**Make sure to read and follow all safety procedures to avoid electric shock and/or injury.**

The meter is a safe, reliable, yet small handheld 3 ½ digit digital clamp meter. Capable of measuring AC current, AC/DC voltage, resistance, and continuity, it's ideal for both home users and professionals.

## 2. Safety Instructions

### WARNING

**The special attention should be paid when using the meter because the improper usage may cause electric shock and damage the meter. The safety measures in common safety regulations and operating instruction should be complied with when using. In order to make full use of its functions and ensure safe operations please comply with the usage in this section carefully.**

The meter is designed and manufactured according to safety requirements of EN 61010-1:2010, EN 61010-2-032, EN 61010-2-033 on electronic measuring instrument and hand held digital multipurpose meter. And conforms to UL STD. 61010-1, 61010-2-032, 61010-2-033, Certified to CSA STD. C22.2 NO. 61010-1, 61010-2-032, 61010-2-033. The product meets with the requirements of 600V CAT III and pollution degree 2.

All safety guidelines outlined should be followed otherwise the protection provided by the instrument may be impaired.

Warning symbols in the manual alert users of potential dangerous situations.









Precautions are to prevent the user from damaging the instrument or the test object.

## 2.1 Precautions

To avoid possible electric shock, personal injury or damage to the meter, please observe the following:

1. Before using the meter, check the meter for damage during transport.
2. Check the test leads for damage to the insulation or wires before use.
3. Ensure the meter works properly by testing a known voltage first. If not working properly, have the meter serviced before using.
4. Never exceed the protection limit values indicated in the specifications for each range of measurement.
5. Always use caution when making voltage measurements above 60V dc or 30V ac rms.
6. Make sure to use the correct input jack, function and range when measuring.
7. Do not place the meter in any environment with dust, explosive gas or vapor.
8. Always keep fingers behind the probe barriers.
9. Connect the common test lead first, then the hot lead. Disconnect in reverse order.
10. Turn off power and discharge capacitors before measuring resistance, diodes or continuity.
11. Failure to follow safety guidelines may prevent the meter's built in protection from working properly.
12. To avoid damage or incorrect readings, check for AC voltage present before making DC voltage measurements.
13. Do not use the meter with the battery cover not securely in place.
14. When the " "symbol appears, replace the batteries to avoid incorrect readings
15. Before opening the case, always disconnect test leads from all energized circuits.
16. Only use the test leads provided with the meter. Replace only with similar leads with matching specifications.
17. Do not touch input jacks during measurement to avoid electric shock.
18. Before switching functions, remove test leads from an circuit.

## 2.2 Safety Symbols

	Note-Important safety information; refer to the instruction manual.
	Application around and removal from UNINSULATED HAZARDOUS LIVE conductors is permitted
	Caution, possibility of electric shock
	Equipment protected throughout by double insulation or reinforced insulation.
	CONFORMS TO UL STD 61010-1, 61010-2-032 and 61010-2-033; CERTIFIED TO CSA STD C22.2 NO. 61010-1, 61010-2-032, 61010-2-033
	Complies with European (EU) safety standards
	Earth (ground) TERMINAL
	AC volatge/current
	DC volatge

### CAT III:

Applicable to test and measuring circuits connected to the distribution part of the building's low-voltage MAINS installation. Example: fixed equipment switchboards, circuit breakers, wiring, including cables, bus bars, junction boxes, switches, sockets, utput terminals on devices for industrial use and other equipment.

## 3. Description

### 3.1 Front Panel

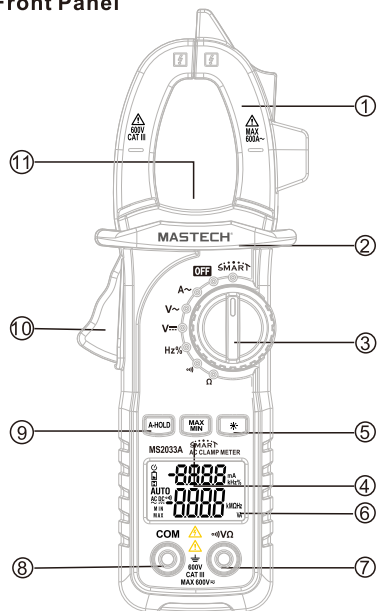

#### 1. Current Clamp

For measuring AC current.

#### 2. Safety barrier

Helps to keep hands from touching conductors while measuring current.

#### 3. Rotary Switch

Used to select function and range.

## 4. MAX/MIN

Press “MAX/MIN” key, the display will show the maximum reading value among measuring data, and the “MAX” symbol appears on the display, press the button again, the “MIN” symbol appears on the display and will show the minimum reading value among measuring data, press the button again to return to normal mode

## 5. Backlight

☼ button to turn on the backlight. The worklight will turn on as well when the rotary switch is in one of the current positions.

## 6. Display

Max. display value: 5999

## 7. Input Jack

Connection for the live (red) test lead for voltage, resistance, capacitance, diodes and continuity.

## 8. COM Jack

Connection for the common (black) test lead.

## 9. A-HOLD

Press the “A-HOLD” button and the display will keep the reading on the screen unless the data is more than 5%. press the “A-HOLD” button again to return the display to normal.

## 10. Clamp Trigger

Press the trigger to open the clamp jaw; release to close.

## 11. Worklight

When the rotary switch is in one of the current positions and the Worklight is turned on, the worklight will turn off in a minute.

## 3.2 Display

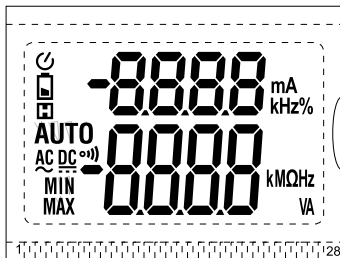

Symbol	Description
<b>AUTO</b>	Auto-range
~	AC voltage/current
⎓	DC voltage
🔋	Low Battery
%	Percentage (duty cycle)
Hz	Hertz (frequency)
V	Volts (Voltage)
A	Amps (Current)
Ω, kΩ, MΩ	Ohms (resistance)
o )	Continuity
⏻	Display Hold
⚡	Polarity Indicator (Negative)

## 4. Using the Meter

### 4.1 Data Auto

Move the rotary switch to the "smart" position. The default mode is "AC Current", "AC Voltage", "DC Voltage", "Resistance" or "Continuity", Connect the test leads across the circuit or load to be measured, It will Automatic judgement.

When used the meter to measure the AC current, the meter also can display the measurement (for example DCV or ACV or ohms or continuity) that measured from the jaw of the meter at the same time.

### 4.2 A-Hold

Press the "A-HOLD" button and the display will keep the reading on the screen unless the data is more than 5%. Press the "A-HOLD" button again to return the display to normal.

### 4.3 Auto Power Off

If the meter is not used for approx. 15 min., the meter will automatically turn itself off to conserve battery power. To turn the meter back on after auto off, press the "A-HOLD" button.

### 4.4 DC Voltage

1. Insert the red test lead in the "INPUT" jack and the black lead in the "COM" jack.
2. Move the rotary switch to the "V⎓" position. The default mode is DC voltage. Connect the test leads across the circuit or load to be measured.
3. Read measured voltage on the display.

### ⚠ CAUTION

Use extra caution when measuring high voltages to avoid electric shock or damage.

# MASTECH®



**WARNING**  
**Do not attempt to measure voltages above 600V DC to prevent injury or damage to the meter.**

## 4.5 AC Voltage

1. Insert the red test lead in the “**INPUT**” jack and the black lead in the “**COM**” jack.
2. Move the rotary switch to the “**V~**” position. Connect the test leads across the circuit or load to be measured.
3. Read measured voltage on the display.



**CAUTION**  
**Use extra caution when measuring high voltages to avoid electric shock or damage.**



**WARNING**  
**Do not attempt to measure voltages above 600V AC to prevent injury or damage to the meter.**

## 4.6 AC Current

1. Move the rotary switch to the “**A~**” position with the proper range.
2. Press the trigger to open the clamp and insert one conductor inside the jaws. Only clamp one conductor; multiple conductors with different current directions will cancel out readings.
3. Read measured current on the display.

# MASTECH®

## 4.7 Resistance

1. Turn off all power and discharge capacitors on the circuit under test.
2. Insert the red test lead in the “**INPUT**” jack and the black lead in the “**COM**” jack.
3. Move the rotary switch to the “**Ω**” position. Connect the test leads across the circuit to be measured.
4. Read measured resistance on the display.

Tips for measuring resistance:

- Sometimes the resistor value and measured resistance differ. This is due to the meter’s output test current goes through all possible paths between leads.
- For low resistance measurements, short the test leads and record the resistance displayed. Then connect to the circuit and subtract the recorded resistance from the measurement for the most accurate results.
- When leads are disconnected or measurement is out of range, “**OL**” is displayed.



**WARNING**  
**To avoid injury or damage to the meter, make sure to turn off all power and discharge all capacitors before measuring resistance.**

## 4.8 Continuity

1. Turn off all power and discharge capacitors on the circuit under test.
2. Insert the red test lead in the “**INPUT**” jack and the black lead in the “**COM**” jack.
3. Move the rotary switch to the “**•|•**” position. Connect the test leads across the circuit to be measured.
4. Read measured resistance on the display. If the measured resistance is less than 40Ω, the meter’s buzzer will sound.

## WARNING

To avoid injury or damage to the meter, make sure to turn off all power and discharge all capacitors before measuring continuity.

### 4.9 Frequency/Duty Cycle

1. Insert the red test lead in the “INPUT” jack and the black lead in the “COM” jack.
2. Move the rotary switch to the “Hz%” position. Connect the test leads across the circuit to be measured.
3. Read measured Frequency on the display.
4. Read measured duty cycle on the display.

## 5. Specifications

### 5.1 General Specifications

Safety rating	CAT III 600V
Max. operating altitude	2000m
Operating temperature	0~40°C, <80% RH
Storage temperature	-10~60°C, <70% RH (battery removed)
coefficient	0.1 accuracy/°C
Max. voltage between terminals and ground	600V DC or AC rms
Sample rate	approx. 3 times/sec
Display	3 ½ digit LCD (max. display: 5999/1999(Resistance))
Over-range indication	display only shows “OL”
Low battery indication	when battery voltage drops below operating voltage, “  ” symbol appears on the display
Polarity indication	automatically displays “-”
Power	3x 1.5V AAA batteries
Dimensions	204mmX78mmX43mm
Weight	195g
Max. jaw opening	26mm

## 5.2 Technical Specifications

Accuracy:  $\pm$ (% of reading + digits), 1 year warranty.

Ambient temp: 18°C~28°C, humidity: <75%.

Temperature coefficient: 0.1accuracy/°C  
(0°C~18°C or 28°C~40°C)

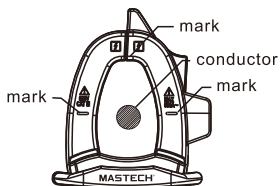

For AC current measurement, keep the conductor in the center of the clamp; otherwise the reading can deviate as much as 2.5% of actual measurement.

### 5.2.1 DC Voltage

Range	Resolution	Accuracy
6V	0.01V	$\pm$ (0.5% of reading+3 digits)
60V	0.1V	
600V	1V	

- Input impedance: 10M
- Overload protection: 600V DC or AC rms
- Measuring range: 1V~600V DC
- Max input voltage: up to 600V for no more than 60 seconds.

NOTE :When alternating current is detected at either the DC voltage or the AC voltage shift, the LCD will display " Err "

## 5.2.2 AC Voltage

Range	Resolution	Accuracy
6V	0.01V	$\pm$ (0.8% of reading+5 digits)
60V	0.1V	
600V	1V	

- Input impedance: 10M $\Omega$
- Overload protection: 600V DC or AC rms
- Measuring range: 1V~600V AC
- Max input voltage: up to 600V for no more than 60 seconds.
- Frequency range: 45Hz~65Hz
- Response: Average; calibrated to rms sine wave

### 5.2.3 AC Current

Range	Resolution	Accuracy
2A	0.01A	$\pm$ (2.5% of reading+8 digits)
20A	0.01A	
200A	0.1A	
600A	1A	$\pm$ (3.0% of reading+10 digits)

- Frequency range: 45Hz~65Hz
  - Max input current: up to 600A for no more than 60 seconds.
  - Measuring range: 0.4A~600A AC
  - Response: Average; calibrated to rms sine wave
- NOTE: Only when the current value is greater than 0.8A, the meter will show its frequency value.

NOTE: When there is voltage or resistance detected in the AC current shift, the LCD will display "Err"



## 5.2.4 Resistance

Range	Resolution	Accuracy
2KΩ	0.001KΩ	±(0.8% of reading+3 digits)
20KΩ	0.01KΩ	
200KΩ	0.1KΩ	
2MΩ	0.001MΩ	
10MΩ	0.01MΩ	±(1.0% of reading+5 digits)

- Measuring range: 0Ω~10MΩ
- Open circuit voltage: approx. 0.4V
- Overload protection: 250V DC or AC rms

## 5.2.5 Continuity

Range	Function
o))	If the measured resistance is less than 40Ω, the meter's buzzer will sound.

- Open circuit voltage: approx. 0.4V
- Overload protection: 250V DC or AC rms

## 5.2.6 Frequency (V position)

Range	Resolution	Accuracy
60Hz	0.1Hz	±(1.0% of reading+5 digits)
600Hz	1Hz	
3kHz	10Hz	

- Measuring range: 40~3kHz.
- Input voltage range: ≥1V AC rms. (measured frequency will increase as the input voltage increases)
- Overload protection: 600V DC or AC rms

## 5.2.7 Duty Cycle

Range	Resolution	Accuracy
10%~90%	1%	±2.0%

## 6.Maintenance

### WARNING

**Protection impairment if used in a manner not specified by the manufacturer.**

### 6.1 General Maintenance

This section provides basic maintenance principles, including cleaning and battery replacement. Do not attempt to do any repair or calibration to the meter unless you are experienced maintenance personnel.

### WARNING

**Remove test leads from meter before opening the battery cover to avoid damage or injury.**

Use a damp cloth and a small amount of detergent to clean the meter regularly. Do not use abrasives or chemical solvents. Dirty or wet input jacks can affect readings.

To clean the input jacks:

1. Turn off meter and remove test leads.
2. Wipe any debris off input jacks.
3. Use a cotton swab with a cleaner/lubricant (i.e. WD-40) to clean jacks.
4. Use a new swab for each jack to prevent cross contamination.

## 6.2 Replacing the Batteries

### WARNING

To avoid false reading that can lead to injury or damage to the meter, replace the battery as soon as the low battery symbol “” appears. Remove test leads and disconnect from all circuits before opening the battery cover.

To replace the batteries:

1. Battery Specifications : size AAA 1.5V
2. Turn off the meter and remove test leads.
3. Unscrew the battery cover.
4. Replace the used batteries with new ones.  
Be sure to observe polarity when replacing batteries.
5. Replace battery cover and tighten before use.

## 6.3 Replacing Test Leads

### WARNING

Use meet EN 61010-031 standard, rated CAT III 600V or better Test leads.

### WARNING

When replacing test leads, only use similar leads or leads with same specs as those provided. Lead specs: 600V, 10A

Replace test leads if leads become damaged or worn.

## 7. Accessories

User's manual	1 piece
Test leads	1 pair
Case	1 piece
AAA batteries (1.5V)	3 pieces

