

# MASTECH<sup>®</sup>

## MS5901

### Three Phase Rotation Indicator User's Manual

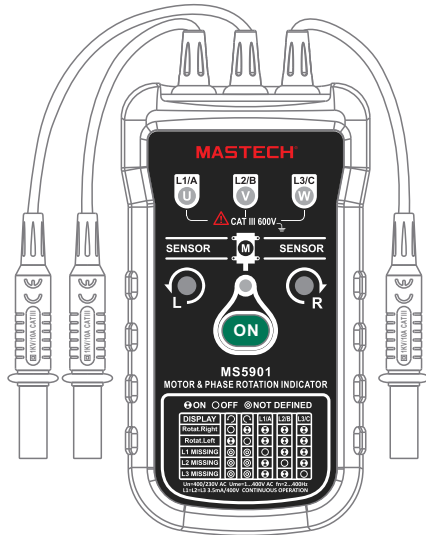

Intertek



## CONTENTS

Introduction.....	1
Accessories.....	1
Safety Information.....	2
Symbols.....	4
Elements Of The Apparatus.....	5
Using the Motor & Phase Rotation Indicator.....	6
Determine Rotary Field Direction.....	6
Non-Contact Rotary Field Indication.....	8
Determine The Motor Connection.....	10
Magnetic Field Detection.....	11
Maintaining The Apparatus.....	11
Cleaning.....	12

## CONTENTS

Replacing And Disposing Of The Batteries.....	12
Specifications.....	14

### List of Tables

1. Symbols.....	4
2. Reliable Motor Test Requirements.....	10

### List of Figures

1. Motor And Phase Rotation Indicator.....	4
2. Phase Indication Table.....	7
3. Motor Rotation.....	9
4. Battery Replacement .....	13

## Introduction

Motor and Phase Rotation Indicator is a handheld, battery-operated instrument designed to detect the rotary field of three-phase systems and determine motor-rotation direction.

Protection provided by the instrument will be impaired if used in a manner not specified by the manufacturer.

## Accessories

Motor and Phase Rotation Indicator ships with the following items:

- 3 test probes
- 3 alligator clips
- 9 V battery
- Users Manual

If an item is damaged or missing, contact the place of purchase immediately.

## Safety Information

### CAUTION

identifies conditions and actions that may damage the apparatus.

### WARNING

identifies conditions and actions that pose hazard(s) to the user.

### Read First

Safety Information To avoid possible electric shock or fire, do the following:







- Read the following safety information carefully before using or servicing the instrument.
- Adhere to local and national safety codes.
- Individual protective equipment must be used to prevent shock and injury
- Use of instrument in a manner not specified by the manufacturer may impair safety features/protection provided by the equipment.
- Avoid working alone.
- Inspect the test leads for damaged insulation or exposed metal. Check test lead continuity. Damage leads must be replaced. Do not use the apparatus if it looks damaged.

- Be careful when working above 30 V ac rms, 42 V ac peak and 60 V dc. Such voltages pose a shock hazard.
- When using the probes, keep fingers away from probe contacts. Keep fingers behind the finger guards on the probes.
- Measurements can be adversely affected by impedances of additional operating circuits connected in parallel or by transient currents.
- Verify operation on a known source prior to measuring hazardous voltages (voltages above 30 V ac rms, 42 V ac peak and 60 V dc).
- Do not use the apparatus with any of the parts removed.
- Do not use the apparatus around explosive gas, vapor, or dust.
- Disconnect the test leads from power sources and the apparatus before changing the battery.
- Do not use the apparatus in a wet environment.

## Symbols

The following symbols appear on the Motor and Phase Rotation Indicator or in this manual.

**Table 1. Symbols**

	Caution, risk of danger
	Earth(ground) TERMINAL
	Alternating current
	Direct current
	Complies with European (EU) safety standards
	Equipment protected throughout by DOUBLE INSULATION or REINFORCED INSULATION
	CONFORMS TO UL STD. 61010-1, 61010-2-030, 61010-031; CERTIFIED TO CSA STD. C22.2 No. 61010-1, 61010-2-030, 61010-031

**CAT III:** MEASUREMENT CATEGORY III is applicable to test and measuring circuits connected to the distribution part of the building's low-voltage MAINS installation.

## Elements Of The Apparatus

Indicators, buttons, and jacks are shown in Figure 1.

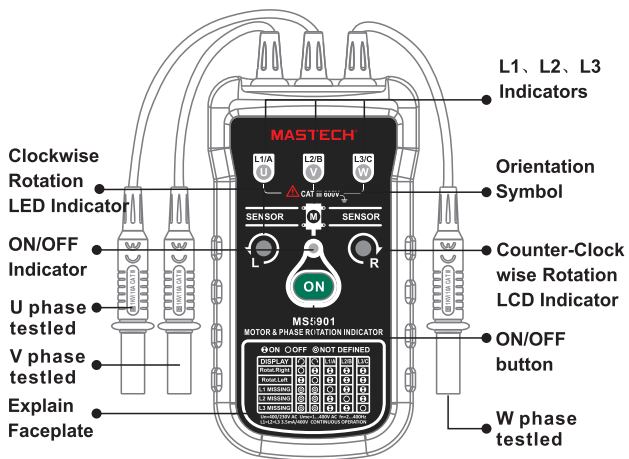

Figure 1.

## Using The Motor & Phase Rotation Indicator

### Determine Rotary Field Direction

To determine the rotary field direction:

1. Connect the test probes to the end of the test leads. Make sure the L1, L2 and L3 are connected to the corresponding end of test leads.
2. Connect the test probes to the three mains phases. Press the ON/OFF button. The green ON indicator shows that the instrument is ready for testing. Either the Clockwise or Counter Clockwise Rotary indicator illuminates showing the type of rotary field direction present.

## The rotary indicator lights



**WARNING**

if the neutral conductor, N, is connected instead of L1, L2, or L3. Refer to Figure 2 (also shown on the face of the apparatus) for more information.

	⊗ ON	○ OFF	⊙ NOT DEFINED			
DISPLAY	↻	↺		L1/A	L2/B	L3/C
Rotat.Right	○	⊗	⊗	⊗	⊗	⊗
Rotat.Left	⊗	○	⊗	⊗	⊗	⊗
L1 MISSING	⊙	⊙	○	⊗	⊗	⊗
L2 MISSING	⊙	⊙	⊗	○	○	⊗
L3 MISSING	⊙	⊙	⊗	⊗	○	○

Un=400/230V AC Ume=1...400V AC fn=2...400Hz

**Figure 2. Phase Indication Table (shown on the face of the apparatus)**

## Non-Contact Rotary Field Indication

For non-contact rotary field indication:

1. Disconnect all test probes or alligator clips from the apparatus.
2. Position the Indicator on the motor so that it is parallel to the length of the motor shaft. The Indicator should be one inch or closer to the motor. See Figure 3.

3. Press the ON/OFF button. The green ON indicator shows that the instrument is ready for testing. Either the Clockwise or Counter Clockwise Rotary indicator illuminates showing the type of rotary field direction present.

## Note

The Indicator will not operate with engines controlled by frequency converters. The bottom of the apparatus should be oriented towards the drive shaft. See the Orientation Symbol on the apparatus.

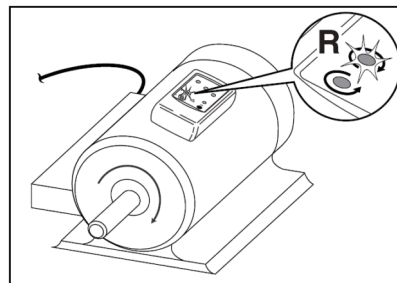

**Figure 3. Motor Rotation**

See Table 2 for the minimum motor diameter and number of pole pair to obtain a reliable test result.

**Table 2. Reliable Motor Test Requirements**

Number of Pole Pair	Rotary Number of Rotary Field (1/min) at Frequency (Hz)			Angle Between Poles	Min. $\varnothing$ of Motorcase
	16 2/3	50	60	°	cm
1	1000	3000	3600	60	5.3
2	500	1500	1800	30	10.7
3	333	1000	1200	20	16.0
4	250	750	900	15	21.4
5	200	600	720	12	26.7
6	167	500	600	10	32.1
8	125	375	450	7.5	42.8
10	100	300	360	6	53.5
12	83	250	300	5	64.2
16	62	188	225	3.75	85.6

### Determine the Motor Connection

1. Connect the alligator clips to the other end of the test leads.
2. Connect the alligator clips to the motor connections, L1 to U, L2 to V, L3 to W.
3. Press the ON/OFF button. The green ON indicator shows that the instrument is ready for testing.
4. Turn the motor shaft half a revolution towards the right.

### Note

The bottom of the apparatus should be oriented towards the drive shaft . See the Orientation Symbol on the apparatus.  
 Either the Clockwise or Counter Clockwise Rotary indicator illuminates showing the type of rotary field direction present.

## Magnetic Field Detection

To detect a magnetic field, place the apparatus to a solenoid valve. A magnetic field is present if either the Clockwise or the Counter Clockwise Rotary indicator illuminate.

## Maintaining The Apparatus

This section provides basic maintenance information.

### Caution

To avoid damaging the apparatus:

- Do not attempt to repair or service the apparatus unless qualified to do so.
- Make sure that the relevant calibration, performance test, and service information is being used.

## Cleaning

Periodically wipe the case with a damp cloth and mild detergent. Clean only with soap and water and remove any residue afterwards.

### Caution

To avoid damaging the apparatus:

- Do not use abrasives or solvents. Abrasives or solvents will damage the apparatus case.
- Prior to cleaning, remove test leads from the apparatus.

## Replacing And Disposing Of The Batteries

### Warning

To avoid electric shock, disconnect the test leads from the source before opening the apparatus for battery replacement.

### Note

The apparatus contains alkaline batteries. Do not dispose of these batteries with other solid waste. Used batteries should be disposed of by a qualified recycler or hazardous materials handler.



The apparatus uses a 9 V battery (supplied). To replace the battery, follow these steps and refer to Figure 4:

1. Disconnect test leads from any power source.
2. Place the apparatus face down on a nonabrasive surface and loosen the battery-door screw with a screwdriver.
3. Lift the battery access lid away from the apparatus.
4. Replace the battery as shown in Figure 4.  
Observe the battery polarity shown in the battery compartment.
5. Secure the battery access lid back in position with the screw.
6. Place the apparatus back in the holster.

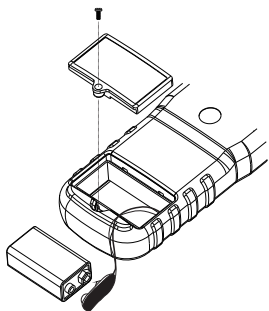

**Figure 4. Battery Replacement**

## Specifications

<b>Environmental Operating Temperature</b>	0 °C to +40 °C
<b>Operating Altitude</b>	2000 m
<b>Pollution Degree</b>	2
<b>Mechanical Specifications</b>	131 x 72 x 30 mm (5.2 x 2.8 x 1.2 in)
<b>Weight</b>	approx 252 g (0.6 lbs)
<b>Humidity</b>	15 % to 80 %

## Safety Specifications

<b>Electrical Safety</b>	Meets DIN VDE 0411 IEC 61010 DIN VDE 0413-7 EN 61557-7 IEC 61557-7
<b>Maximum Operating Voltage (Ume)</b>	400 V AC for all ranges
<b>Protection Level</b>	CAT III 600 V

## Electrical Specifications

<b>Battery</b>	6F22/9V
<b>Current Consumption</b>	max 20 mA
<b>Battery Life</b>	minimum 1 year for average use

## Determine Rotary Field Direction

<b>Nominal Voltage Rotary Direction</b>	1 to 400 V AC
<b>Nominal Voltage Phase Indication</b>	120 to 400 V AC
<b>Frequency Range (fn)</b>	2 to 400 Hz
<b>Test Currents (In per phase)</b>	less than 3.5 mA

## Non-Contact Rotary Field Indication

<b>Frequency Range (fn)</b>	2 to 400 Hz
-----------------------------	-------------

## Determine the Motor Connection

<b>Nominal Test Voltage (U<sub>me</sub>)</b>	1 to 400 V AC
<b>Nominal Test Currents (In per phase)</b>	less than 3.5 mA
<b>Frequency Range (fn)</b>	2 to 400 Hz

