

UT151A/B/C/D/E

Operating Manual



Modern Digital Multimeters

I. OVERVIEW

Brand-new UT151 series are 2000-count handheld digital multimeters featuring remarkably stable and reliable operations. They are designed with the large-scale integrated circuits and dual integral A/D converter and also offer overload protection for all ranges. The series can measure DC&AC voltage, DC&AC current, resistance, capacitance, diode, transistor, temperature, frequency, battery and continuity, which make it a perfect solution for your work.









II. SAFETY INFORMATION

This instrument is designed and manufactured in compliance with: GB4793, IEC61010-1, IEC1010-2-032, CATII 600V, Pollution Degree 2 and Double Insulation standards.

Warning

- Please operate the instrument as specified in the manual, otherwise the protection offered by the instrument would be compromised.
- Ensure that it cannot be operated before the back cover is put in the place, otherwise there is a risk of electric shock.
- The range switch shall be installed at the correct position.
- Check and ensure the insulation layer of the test leads is in good condition without damage and broken line.
- The red and black test leads should be inserted in the proper terminals and ensured with good contact.
- The input signal is not allowed to exceed the limit value to avoid electric shock and damage.
- Switching the range is strictly prohibited during the measurement of voltage and current in order to avoid damaging the instrument.
- Use only the replacement fuse with the same model or identical electrical specifications.
- In order to avoid electric shock, the potential difference between common port "COM" and the "⊥" earth is not exceeded 600V.
- When the voltage to be measured is more than 60 DC or 30 Vrms AC, you must be careful to avoid electric shock.
- When the LCD shows the symbol of , you must change the battery in time to ensure the measuring accuracy.
- Turn off the power after finishing the measurement. If you do not use it for a long time, take out the battery.
- Don't operate this instrument under high temperature or high humidity. Especially, it cannot be stored in damp environment. If the instrument is affected with damp, its performance will be compromised.
- Don't change the circuits of the instrument at random, otherwise, you will damage the instrument and be in danger.
- Clean the instrument casing with slightly damp cloth and mild agent. No abrasives and solvents are allowed.

International Electrical Symbols

	Lower battery level		Grounding		Warning
	Buzzer		AC		DC
	Fuse		Double insulation		Diode

III. PRODUCT FEATURES

- There are 30 ranges for function selection.
- LCD display with visible zone 63×29mm.
- Over-range indication "1".
- Display Count: 1999.
- Overload protection for the full range.
- Auto Power Off.
- Temperature Range: Working: 0°C ~ 40°C (32°F ~ 104°F); Storage: -10°C ~ 50°C (14°F ~ 122°F).
- Low Battery Indication:  on upper left corner of LCD.
- Data Hold
- Physical dimensions: 186mm x 91mm x 39mm
- Weight: Approximate 300g (Main unit+holster+tilt stand+battery, excluding test leads)

IV. TECHNICAL SPECIFICATIONS

Accuracy: ±(a% reading + digit); the guarantee period is 1 year.
Ambient temperature: 23°C ± 5°C
Relative humidity: <75%

DC voltage

Range	Resolution	Accuracy				
		UT151A	UT151B	UT151C	UT151D	UT151E
200mV	100μV	±(0.5%+1)				
2 V	1 mV					
20 V	10mV					
200 V	100mV					
600 V	1 V	±(0.8 %+2)				

Input impedance: 10MΩ for all ranges
Overloading protection: For 200mV range, 600V, DC or AC RMS. For other ranges, 600Vrms or 850Vp-p peak value.

AC voltage

Range	Resolution	Accuracy				
		UT151A	UT151B	UT151C	UT151D	UT151E
2 V	1 mV	±(0.8%+3)				
20 V	10mV					
200 V	100mV					
600 V	1 V					

Input impedance: 10 MΩ for all ranges
Frequency range: 45Hz-400Hz
Overloading protection: 600Vrms or 850Vp-p peak
Display: Mean value(RMS value of sinewave)

DC current

Range	Resolution	Accuracy				
		UT151A	UT151B	UT151C	UT151D	UT151E
200 μA	0.1μA	±(0.8%+1)				
2 mA	1μA					
20 mA	10μA	±(0.8%+1)				
200 mA	100μA	±(1.5%+1)				
10 A	10 mA	±(2.0%+5)				

Overloading protection: uA, mA input: 200 mA /600V Φ 5 X 20 mm
A input end: 10A/600V Φ 6 X 25 mm
Maximum input current: 10A (For current over 5A, measuring time shall not exceed 15 seconds)
Measured voltage drop: 200mV for full range

AC current

Range	Resolution	Accuracy				
		UT151A	UT151B	UT151C	UT151D	UT151E
200 μA	0.1μA	±(1.0%+3)				
2 mA	1μA	±(1.0%+3)				
20 mA	10μA	±(1.0%+3)				
200 mA	100μA	±(1.8%+3)				
10 A	10 mA	±(3.0%+5)				

Overloading protection: uA, mA input: 200 mA /600V Φ 5 X 20 mm
A input end: 10A/600V Φ 6 X 25 mm
Maximum input current: 10A (For current over 5A, measuring time shall not exceed 15 seconds)

Measured voltage drop: 200mV for full range
Display: Mean value (RMS value of sinewave)

Resistance

Range	Resolution	Accuracy				
		UT151A	UT151B	UT151C	UT151D	UT151E
200 Ω	0.1 Ω	±(1.2%+2)				
2 kΩ	1 Ω					
20 kΩ	10 Ω	±(1.0%+2)				
200 kΩ	100 Ω					
2 MΩ	1 kΩ	±(1.2%+2)				
20 MΩ	10 kΩ	±(1.5%+2)				
200 MΩ	100 kΩ	±[5.0% (reading-10)+10]		-----		±[5.0% (reading-10)+10]

Open circuit voltage: ≤ 700mV (for range of 200MΩ, the open circuit voltage is about 2.8V).
Overloading protection: 600V for all ranges, DC or AC RMS.
Note: At 200MΩ range, the instruments normally displays 10 digits when the test leads are shorted. Please subtract 10 digits from the subsequent measurement readings.
Relative Humidity ≤65% for measurements at 200MΩ range.

Capacitance

Range	Resolution	Accuracy				
		UT151A	UT151B	UT151C	UT151D	UT151E
2 nF	1 pF	±(4.0%+3)				
20 nF	10 pF	±(4.0%+3)				
200 nF	100 pF	±(4.0%+3)				
2 μF	1 nF	±(4.0%+3)				
200 μF	100 nF	≤ 50 μF ± (5.0%+4) > 50μF, for reference only.				

Testing signal: About 400Hz, 40mVrms
UT151A: > 100μF, for reference only. Testing is made after discharging the capacitor.

Frequency



Range	Resolution	Accuracy				
		UT151A	UT151B	UT151C	UT151D	UT151E
2 kHz	1Hz	±(2.0%+5)				
20 kHz	10Hz	±(1.5%+5)				

Input amplitude: 200 mV ≤ input amplitude ≤ 5V (2KHz)
200 mV ≤ input amplitude ≤ 20V (20KHz)
Overloading protection: 600Vrms

Temperature

Range	Resolution	Accuracy	
		UT151C	UT151E
TEMP °C (-40 °C~1000 °C)	-40 °C~0 °C	±(3%+9)	
	0 °C~400 °C		
	400 °C~1000 °C		
TEMP °F (-40 °F~1832 °F)	-40 °F~32 °F	±(3%+10)	
	32 °F~752 °F		
	752 °F~1832 °F		

Continuity and Diodes

Range	Description	Testing conditions
	Display the forward voltage of diode (approximate value), unit "mV"	Forward DC current about 1 mA Reverse DC voltage about 2.8 V
	Resistances: 10Ω, the buzzer sounds; > 10Ω, the buzzer doesn't necessarily sound; Display approximate resistance value, unit: Ω.	Open circuit voltage about 2.8V

Overloading protection: 600V DC or AC effective value



Battery measurement (only for UT151A)

Range	Resolution	Accuracy	Description
12 V	10 mV	±(2.5%+2)	Built-in load resistance: 240Ω
9 V	10 mV		Built-in load resistance: 1.8 KΩ
1.5 V	10 mV		Built-in load resistance: 30Ω

Overloading protection: 500 mA/600V fuse
The damaged fuse must be replaced by the one of the same type.

V. OPERATING METHOD

Precautions before operation:

- 1) Press the POWER switch to check 9v battery. In case of lower battery voltage level, “” will be shown on the display. In this case, you need to replace the battery.
- 2) “” symbol near the input terminals means that input voltage or current shall not exceed the indicated value so that the internal circuits can be protected from damage.
- 3) Prior to the testing, the functional switch shall be placed at the needed range.

4) Multimeter Description

- ① Power switch
- ② LCD display
- ③ Data hold
- ④ Rotary switch
- ⑤ Input Terminals

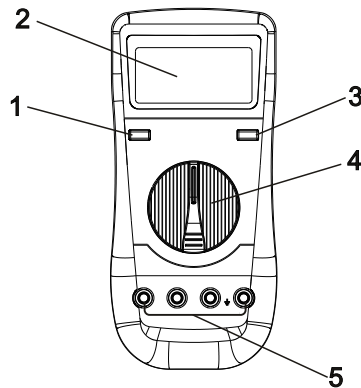

Measuring DC Voltage

- 1) Insert test leads into input terminals(Red to V and black to COM).
- 2) Set the rotary switch to V_{DC} range; Connect test leads to the power or load under test, and the positive polarity of the test end will indicate.

Notice

- 1) If the scope of voltage to be tested is not known, the functional switch shall be placed at the maximum range which will be gradually lowered for testing.
- 2) If the display only shows “1”, it indicates over-range. In this case, the functional switch shall be placed at higher range.
- 3) “” indicates that you must not input a voltage more than 600V. It is possible to show a higher voltage, but it has a risk of damaging the internal circuits.
- 4) Special attention shall be given to measurement of high voltage to avoid electric shock.

Measuring AC Voltage

- 1) Insert test leads into input terminals(Red to V and black to COM).
- 2) Set the rotary switch to V_{AC} range; Connect test leads to the power or load under test.

Notice

- 1) Refer to Notice 1, 2 and 4 in the AC Voltage Measurement
- 2) “” indicates that you must not input a voltage more than 600 V. It is possible to show a higher voltage, but it has a risk of damaging the internal circuits.

Measuring DC current

- 1) Insert the black test lead into COM terminal. For currents \leq 200mA, insert the red test lead into mA terminal. If current goes up to 10A, insert red test lead into 10A terminal.
- 2) Set the rotary switch to A_{DC} range; Connect test leads to the tested circuit in series. The polarity of red test lead will show.

Notice

- 1) If the scope of current to be tested is not known, the functional switch shall be placed at the maximum range which will be gradually lowered for testing.
- 2) If the display only shows “1”, it indicates over-range. In this case, the functional switch shall be placed at higher range.
- 3) “ A_{DC} ” indicates that the maximum input current is 200Ma. The built-in fuse of 200mA/600V Φ 5 x 20 mm can effectively protect the circuit from burn-out. 10A range use fuse of 10A/600V Φ 8 x 25 mm for protection.

Measuring AC Current

- 1) Insert the black test lead into COM terminal. For currents \leq 200mA, insert the red test lead into mA terminal. If the current goes up to 10A, insert red test lead into 10A terminal.

- 2) Set the rotary switch to A_{AC} range; Connect test leads to the tested circuit in series.

 Notice

- 1) Refer to Notice 1, 2 and 3 in the Direct Current Measurement.

Measuring Resistance

- 1) Insert test leads into input terminals(Red to Ω and black to COM).
- 2) Set the rotary switch to Ω range; Connect test leads to tested resistor in parallel.

 Notice

- 1) If the resistance to be tested is more than the maximum value of the range selected, over-range “1” will be shown. You shall select higher range. For resistance more than 1M Ω and above, the reading can become stable after several seconds; this is normal for high resistance reading.
- 2) When input is not made, such as open-circuit conditions, the instrument shows “1”.
- 3) When you check the impedance of internal circuits, power supply to the circuit to be tested must be cut off and all capacitors must be totally discharged.
- 4) There are 10 digits at 200 M Ω short-circuit which shall be subtracted from the reading. For example, 101.0 is shown in measurement of 100 M Ω resistance and the 10 digits shall be subtracted.

Measuring Capacitance

Prior to connection to the capacitance to be tested, note that time for zero reset is needed for each change of range. Existing drift reading cannot influence the testing precision.

 Notice

- 1) Although the capacitance ranges have been protected internally, you still need to discharge all tested capacitors so as to avoid any damage to the instrument or any measurement error.
- 2) In measuring capacitance, insert the capacitor into the capacitance testing seat.
- 3) In measuring large capacitance, it will take a certain time period to get stable reading.
- 4) Unit: 1pF=10⁻⁶ μ F, 1nF=10⁻³ μ F

Measuring Frequency

- 1) Insert test leads into input terminals(Red to Hz and black to COM).
- 2) Set the rotary switch to kHz range; Connect test leads to frequency source. You can read the frequency reading directly from the display.

Measuring Temperature

- 1) In measuring the temperature, insert the cold end (free end) of thermocouple sensor into the temperature terminals and at the same time note the polarity. Place the working end (temperature measuring end) on or inside the object to be tested. You read the temperature directly from the display which is expressed in $^{\circ}C$ or $^{\circ}F$.

Testing Diodes and Continuity

- 1) Insert test leads into input terminals(Red to V_{Ω} and black to COM, “+” for the red test lead). Then set the rotary switch to ; Connect test leads to tested diode. The displayed reading is the approximate value of forward voltage drop of diode.
- 2) Connect test leads to the circuit under test, if the resistance between two tested ends is $< 10 \Omega$, the built-in buzzer sounds.

Auto Power Off

- 1) Auto Power Off circuit is set for the instrument. When working time of the instrument is about 15min, the power is automatically cut off. Then the instrument goes into sleeping state. In this case, the instrument consumes about 7 μ A current.
- 2) If you want to restart the power after power off, press the power switch twice.

VI. MAINTENANCE

This digital universal meter is an electronic precision instrument. Do not change circuits randomly and note the following aspects:

1. Do not connect to voltages higher than 600 V DC or 600AC RMS.
2. Do not connect to the voltage source when the function switch is at “current ranges”, “ Ω ” and “”.
3. Do not use this instrument when the battery is not well connected or its back cover is not tightly installed.
4. You can only change the battery or fuse when the test leads are removed and power is cut-off.

Battery installation or replacement

This product adopts 9V battery. Refer to Fig. 2, install or replace the battery as per the following sequence.

- a. Shut down this product and remove the test leads from input terminals.
- b. Place the product to make its panel face down; unscrew screws on the battery box cover; remove the cover and take the battery out.

- c. After the new battery is installed, install the battery cover and tighten the screws.

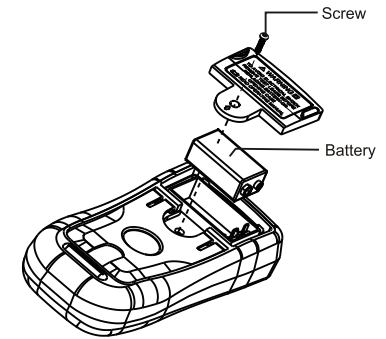

VII. ACCESSORIES

1. Operating Manual	-----	1 pc
2. Test Leads	-----	1 pair
3. Cross point-type thin-line K thermocouple sensor	-----	1 pc
		(only for UT151C and UT151E)

Content of this manual is subject to changes without notice.

Manufacturer:
Uni-Trend Technology (China) Limited
No 6, Gong Ye Bei 1st Road
Songshan Lake National High-Tech Industrial
Development Zone, Dongguan City
Guangdong Province
China
Postal Code: 523 808

Headquarters:
Uni-Trend Group Limited
Rm901, 9/F, Nanyang Plaza
57 Hung To Road
Kwun Tong
Kowloon, Hong Kong
Tel: (852) 2950 9168
Fax: (852) 2950 9303
Email: info@uni-trend.com
http://www.uni-trend.com