

UNI-T®



UT257A/ UT223A Operating Manual

**Super-Large Caliber Lea-
kage Clamp Meter/
Super-Large Caliber Big
Current Meter**



P/N:110401104265X

CONTENT

Warning.....	1
I. Introduction.....	2
II. Model.....	3
III. Electrical Symbols.....	3
IV. Technical Specification.....	4
V. Instrument Structure.....	6
VI. LCD Display.....	7
VII. Method of Operation.....	7
1. Switch On/Off.....	7
2. Data Hold/Storage.....	8
3. Data Access/Exit.....	8
4. Data Upload.....	8
5 Delete Data.....	8
6. General Measurement.....	8
7. PEAK Measurement.....	10
VIII. Battery Replacement.....	10
IX. Accessories.....	11



Warning

Thank you for purchasing our UT257A/UT223A Superlarge Caliber Leakage Clamp Meter/Super Large Caliber Big Current Meter, in order to better use of this product, be sure to:

----To read this user manual carefully.

----Comply strictly with safety rules and precautions set out in this manual.

- ◆ Pay special attention to safety under any circumstances while using the instrument.
- ◆ Take note of the label text and symbols on the panel and back of the instrument.
- ◆ Keep the clamp clean and maintain regularly.
- ◆ Please don't place and store the instrument at the place with high temperature, humidity, moisture condensation and straight sunlight for a long time.
- ◆ Replace battery in time when the battery voltage is low.
- ◆ Remove or replace the battery if you expect not to use the instrument for a long time.

- ◆ Take note of the polarity when replace the battery.
- ◆ The operation, demolition, calibration and maintenance of the instrument must be carried out by qualified personnel authorized to do so.
- ◆ The meter should be stopped from being used immediately and sealed if danger is brought up in case of continued use; only a competent body can be authorized to deal with it.
- ◆ “” in the manual is the safety warning sign, the contents of this manual must be followed for safe operation.
- ◆ “” and other safety signs, the contents of this manual must be followed for safe operation.

I. Introduction

UT257A series of **Super large Caliber Leakage Clamp Meter /Super Large Caliber Big Current Meteris** well designed and manufactured for measuring AC leakage current, current, voltage, adopt the latest CT technology and digital integrated technology. Its large caliber 108mm×148mm can clamp electric cable of 108mm diameter, or 160mm ×4mm flat cable and steel earth wires. Particularly suitable for leakage current measurement of cable and transformer earth steel.

Full automatically and LCD display, all the data are displayed in the screen, which is very clear and convenient. The meter is widely used in electric power, communication, meteorology, railway, oil field, architecture, measuring, teaching research unit, industrial mining enterprises, etc.







UT257A series of **Superlarge Caliber Leakage Clamp Meter**'s clamp core is made of special alloy,

adopt the latest magnetic shielding techniques, to ensure the high precision, high stability and high reliability of perennial uninterrupted measurement. The meter can store 99 sets of data, with RS232 interface, upload stored data to the computer through the system software, implementing online real-time monitoring, historical inquires, dynamic display. With the function of historical data read, preserve, print, and backlight, data hold, etc. It is a necessary tool for electrical safety testing.

II. Model

Model	Range	Resolution	Data Storage	Clamp Size	Note
UT257A	AC 0.0mA- 3200A	0.1mA	99sets	108×148 mm	Measure leakage current
UT223A	AC 0.0A- 4000A	0.1A			Measure big current

III. Electrical Symbols

	Extremely dangerous! The operator must strictly abide by the safety rules; otherwise there is risk of electric shock, resulting in bodily injury or fatalities.
	Dangerous! The operator must strictly abide by safety rules; otherwise there is risk of electric shock, resulting in bodily injury or fatalities.
	Warning! Safety rules must be strictly abided by, otherwise personal injury or equipment damage may be caused.
	Alternate Current (AC)
	Direct Current (DC)
	Double Insulation

IV. Technical Specification

Function	Measure AC leakage current, big current (particularly suitable for leakage current measurement of cable and transformer earth steel)
Power	6V DC (LR6×4 alkaline dry batteries, continuously working for 12 hours)
Test Mode	Clamp CT, integral mode
Clamp Size	108mm×148mm (can clamp electric cable of 108mm diameter, or 160mm×4mm flat cable and steel earth wires)
Measurement Range	UT257A: AC 0.0mA~3200A
	UT223A: AC 0.A~4000A
Resolution	UT257A: AC 0.1mA
	UT223A: AC 0.1A
Measurement Accuracy (23°C±3°C, below 70%RH, measured wire at the center of the clamp)	AC 0.0mA~499A ±2%±5dgt
	AC 500A~999A ±3%±5dgt
	AC 1000A~2999A ±4%±5dgt
	AC 3000A~4000A ±5%±5dgt (Only UT223A)
Measured Wire Position	Measured wire at approximately the geometric center of the clamp

Data Storage	99sets, “ FULL ” symbol indicate the memory is full
RS232 Interface	With RS232 interface, download data to computer for analysis and management
Communication Wire	RS232 communication wire, 1.8m
Frequency	50Hz ,60Hz automatic identification
Gear Shift	Automatic shift
Sample Rate	About 2 times/second
Line Voltage	Below AC 600V line measurement
Display Mode	4 digital LCD display, length 47mm×width 28.5mm
Meter Size	Length 350mm × Width 180mm × Height 55mm
Backlight	Suitable for dim places
Data Hold	“ HOLD ” symbol appears
Overflow	“ OL ” symbol appears
Automatic Shutdown	Automatic ally shutdown about 5 minutes after power on to reduce battery consumption
Voltage Detection	Low battery symbol “  ” appears to remind the replacement of battery when the battery voltage drops below 5.2V.
Weight of Meter	1.5kg (with batteries)
Weight of Package	3kg (with accessories)

Working Temperature and Humidity	0°C ~40°C; below 80%rh
Storage Temperature and Humidity	-10°C ~60°C; below 70%rh
Insulation strength	AC 3700kV/rms(between core and shell)
Safety Specifications	IEC1010-1, IEC1010-2-032, 2 class of pollution, CAT III(600V)

V. Instrument Structure

1. Clamp (108mm×148mm)
2. Lock switch (after lock, the clamp can't be open)
3. **HOLD** key
4. **PEAK** key
5. LCD display
6. RS232 interface
7. Opening lever
8. **POWER** key
9. Battery cover
10. Battery cover screw (1 piece)
11. Up and down cover connecting screws (6 pieces)

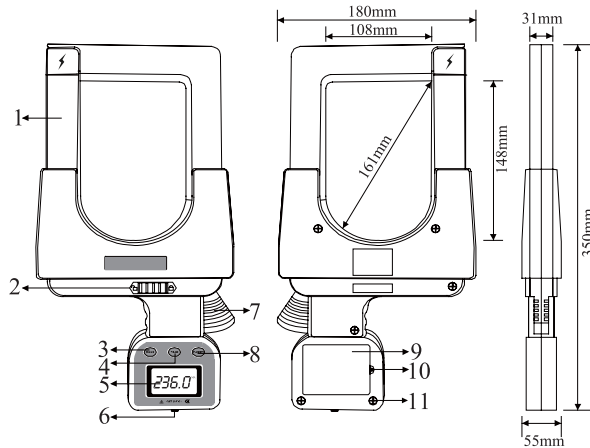

VI. LCD Display

- (1). PEAK measurement mode symbol
- (2). Symbol of low battery & voltage (display when below 4.8V)
- (3). Symbol of data storage
- (4). Symbol of data access
- (5). 2-digit No. of data storage unit

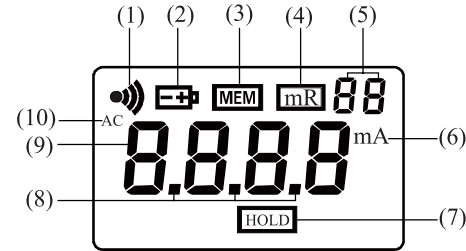

- (6). Current unit (mA or A)
- (7). Data lock symbol
- (8). Metrication decimal point
- (9). 4-digit LCD figures display
- (10). Symbol of AC

VII. Method of Operation

1. Switch On/Off

Press **POWER** key to switch on, LCD display, in test mode, press **POWER** key to switch off. The meter will automatically power off after booting 5

minutes later. If LCD display is darker, maybe the battery voltage is too low, please replace batteries.

In data hold mode, firstly press **HOLD** key to cancel the lock, then press **POWER** key to switch off.

2. Data Hold/Storage

In test mode, press **HOLD** key to lock currently displayed value and display “**HOLD**” symbol. At the same time, this locked value as a set of data followed by auto-ID and store, and “**MEM**” symbol flash one time. The meter can store 99 sets of data. If the memory is full, display “**FULL**” symbol.

3. Data Access/ Exit

In test mode, press **PEAK** and **POWER** key to access data inquiry form group “**R: 01**”, and display “**MR**” symbol. Press **PEAK** or **POWER** key to increase or decrease the page number, it will automatically return back to group 01 when access the last group.

Press **HOLD** key to exit date inquiry, back to test mode.

4. Data Upload

Connecting the meter and computer with USB-RS232 communication line attached in package. Start up the meter, run software, choose history access, then read, save, report, print history data, etc. The more data storage, take the longer time to read it. Historical data can be saved in Txt text or Excel format.

5. Delete Data

In the date inquiry mode, press **PEAK** and **POWER** key to delete all the stored data, and return back to test mode. At the same time, “**dEL**” symbol display.

6. General Measurement

During the measurement, the LCD real-time display the value of measured current and leakage current, the value displayed on LCD change with different current and leakage current. No measured value reserved when take the meter away from measured wires, LCD display zero.

⚡	High voltage, very dangerous! Only qualified personnel after training could conduct operation on it. The operator should obey safety regulations; Otherwise there will be the danger of electric shock resulting in personal injury or casualty.
⚠	Dangerous! Can not be used to test voltage higher than 600V. Otherwise there will be the danger of electric shock resulting in personal injury or casualty.
⚠	Make sure the clamp well closed when measuring leakage current and current.
	Make sure the measured wire at approximately the geometric center of the clamp.
	Clean the clamp after finishing measurement, regularly maintain the meter.
	Clamp live wire and null line together to measure leakage current of electric equipment. (Note: 2 wires)

⚠	Clamp earth wire to measure grounding line leakage current of electric equipment. (Note: single wire)
	Clamp four wires of there phase to measure the total leakage current. (Note: 4 wires)
	Clamp main line to measure total current of that main line. (Note: single wire)

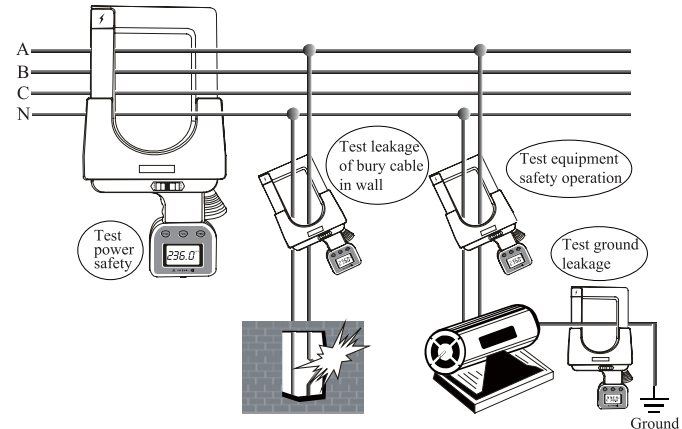



In **HOLD** mode, press **HOLD** key to return back test mode. In data access mode, press **HOLD** key to exit data access, return back to test mode. In **PEAK** mode, press **PEAK** key to exit **PEAK** mode, return back to test mode. After deleting data, it will automatically return back to test mode.

7. PEAK Measurement

The maximum current measurement, during measurement, the meter can automatically compare the changed current, and keep the maximum one. When take the meter away from the measured wire, the measured value can also be kept, so this mode is suitable for the measurement in places where is not easily to read the value displayed on LCD. In general test mode, press **PEAK** key to access or exit **PEAK** test mode. “” symbol displays in **PEAK** measurement mode. In other mode, should first exit and return back to test mode, and then operate **PEAK** measurement as above steps.

VIII. Battery Replacement

	Warning! Make sure the battery cover is well closed before measurement, otherwise there will be danger.
	Take note of the battery polarity, otherwise it may cause damage to the instrument.
	If the battery power is not enough, please change in time.
	Take out the batteries if you expect not to use the meter for a long time.

1. “” is displayed when the power voltage is lower than 5.2V, indicating that the battery should be replaced.
2. Press **POWER** key, make sure the meter is power off. Loosen the battery cover screw, open the plate, replace new batteries and cover the plate, then tighten screw.
3. Press **POWER** key to check whether the batteries are successfully replaced, repeat step 2 if it doesn't work.

IX. Accessories

Main Unit	1 piece
Meter Box	1 piece
RS232 Data Line	1 piece
Disk	1 piece
Battery	4 pieces(Alkaline Dry Battery LR6)
User Manual	1 piece
Guarantee Card	1 piece
Certification	1 piece

Manufacturer:

Uni-Trend Technology (China) Limited
No 6, Gong Ye Bei 1st Road
Songshan Lake National High-Tech Industrial
Development Zone, Dongguan City
Guangdong Province
China
Postal Code:523 808

Headquarters:

Uni-Trend Group Limited
Rm901, 9/F, Nanyang Plaza
57 Hung To Road
Kwun Tong
Kowloon, Hong Kong
Tel: (852) 2950 9168
Fax: (852) 2950 9303
Email: info@uni-trend.com
<http://www.uni-trend.com>