

Instruction Manual MS6541 (IRT730K)

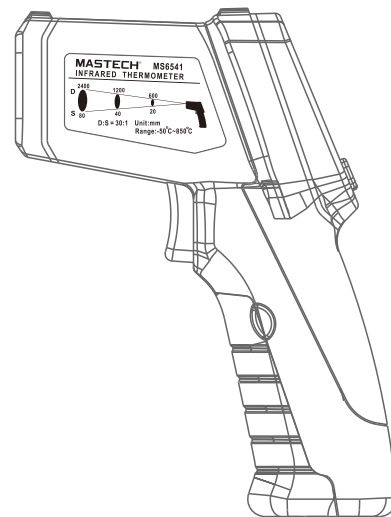

MASTECH®

1. Product Overview

Thank you for purchasing our infrared thermometer. This product is a professional, hand-held meter for non-contact infrared and K-type thermocouple temperature measurements that is simple to use, highly accurate, and with a wide temperature range.

2. Features

- Fast measurement
- on-contact infrared and precision k-type temp measurement
- uilt-in dual laser sight for faster and more accurate targeting
- djustable Emissivity: 0.1 to 1.0 range for multiple surface types
- emp. unit conversion, maximum, minimum, average, difference displays
- ecord up to 99 readings
- esolution: 0.1°C (0.1°F)
- igh temperature alarm setting
- utomatic range, data hold, and auto power functions

3. Uses

This product is widely used in food services, security, fire prevention, chemical, storage, and transport industries

MASTECH®

4. Safety Information

- when laser beam is active, use with caution
- DO NOT aim laser beam at a person's/animal's eyes
- DO NOT use the laser beam near explosive gas



5. Distance to Spot Ratio

The distance to spot ratio (D:S) for this meter is: 30:1. Example: Measurement from a distance of 300mm away will produce a measurement spot of approx. 10mm in diameter. Figure 1 shows a diagram of how distance to spot ratio works.

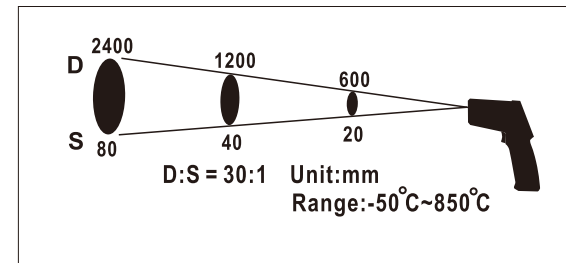

MASTECH®

6. Technical Specifications

Model	IRT730	
Range	IR: -50~760°C/-58~1400°F TK: -50~300°C/-58~572°F	
Accuracy	IR: -50~0°C/-58~32°F:	±4°C/7.2°F
	IR: 0~400°C/32~752°F:	±1.5%, ±2°C/3.6°F
	IR: 400~760°C/752~1400°F:	±2%, ±2°C/3.6°F
	TK: -50~300°C/-58~572°F:	±1.5%, ±3°C/5.4°F
D:S	30:1	
Emissivity	Adjustable: 0.10~1.0	
Resolution	0.1°C(0.1°F)<1000, 1°C(1°F)>1000	
Response Time	<500ms	
Spectral Response	8~14µm	
Low/High Alarm	Low	High
Polarity Display	Automatic (no indication for positive)	
	“-“ indicates negative	
Auto Power Off	IRT will turn off after 30s of non-use	

MASTECH®

Operating Temperature	0°C~50°C/32°F~122°F
Storage Temperature	-20°C~60°C/-4°F~140°F
Relative Humidity	Operating: 10~90% RH, Storage: <80% RH
Battery	9V battery
Weight	252g
Dimensions	176x125x49mm
Safety	Compliance with European CE safety standards

Note:

- alibration is carried out at a temperature between 18° and 28 ° (64° to 82°) and relative humidity below 80%.
- ake sure that the target is larger than the meter' visual spot size. The smaller the target, the closer the meter should be.

MASTECH®

7. Buttons and Components

- 1.Laser Sight
- 2.Infrared Sensor
- 3.Measurement Trigger
- 4.Battery Cover
- 5.Type-K Thermocouple Jack
- 6.Mode Button
- 7.Laser/Backlight Button
- 8.Temp. Unit Button
- 9.LCD Display

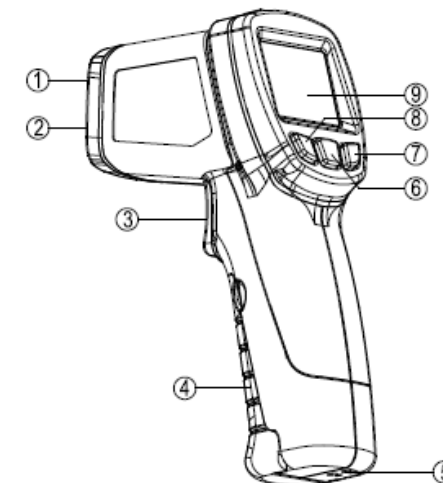

MASTECH®

8. Display Description

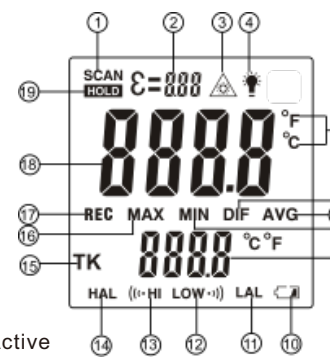

- 1.Scan Active
- 2.Emissivity Value
- 3.Laser
- 4.Backlight
- 5.Temp. Units
- 6.Difference
- 7.Average Reading
- 8.Minimum Reading
- 9.Secondary Function Display
- 10.Low Battery
- 11.Low Alarm Setting
- 12.Low Alarm Active
- 13.High Alarm Active
- 14.High Alarm Setting
- 15.Type-K Temperature
- 16.Maximum Reading
- 17.Memory Storage
- 18.Main Measurement Display
- 19.Data Hold

9. Operating Instructions

9.1 Measurement

1. Point the meter at the object to be measured.
2. Hold down the trigger to begin measurement.
The "SCAN" symbol flashes in the upper left corner of the display to indicate measurement taking place.
3. The main measurement display show the current temperature reading of the measured surface.
4. Release the trigger and "HOLD" symbol will appear in the upper left corner and the display will hold the last reading.
5. The meter's auto off function will turn off the meter 35s after releasing the trigger.

Note:



- Environmental temperature can affect the accuracy of the reading. It is recommended the meter be place in the measurement environment for 30 min. prior to taking measurement.
- Laser can be turned off for measurements at close range to conserve battery power.



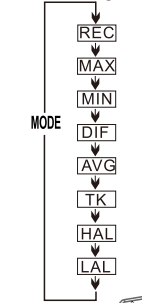

9.2 Function Buttons

9.2.1 Mode

9.2.1.1 While the thermometer is on, press  to switch between functions according to the following graph:



Note: In "REC" mode, press  or  to cycle through all stored readings.

9.2.1.2 While the thermometer is on, hold  and the "ε" symbol will flash, allowing for adjustment of the emissivity value. You can increase or decrease the value using the  or  buttons. Pressing the  button once will let you adjust the high alarm setting and pressing it again will adjust the low alarm setting. Hold the  button to return to normal mode.

9.2.2 Laser/Backlight During measurement, press  to turn on/off the laser pointers. In "HOLD" mode, press the button to turn on/off the backlight.

Note: This function works in all modes except "REC" mode.
9.2.3 Temperature Units In any mode except "REC" press  to switch between Celsius/Fahrenheit.

9.3 Battery Replacement

When the battery is running low, the  symbol will appear indicating the battery needs to be replaced. Open the battery cove and replace the old battery with a new 9V battery.

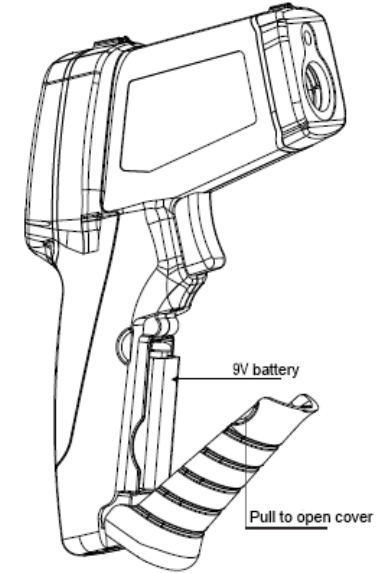

10. Additional Notes

10.1 Thermometer

- Infrared thermometers are used to measure surface temperature.
- The sensor collects infrared energy and is gathered in the detector circuit and converted into a temperature reading for display.
- The laser pointers are only used for aiming purposes

10.2 Surfaces

- Make sure the object to be measured is larger than the diameter of the thermometer's spot field.
- The smaller the target, the closer the meter should be.

10.3 Distance to Spot Size

- As the distance between the surface to be measured and the meter increases, the spot increases according to the ratio 30:1.

10.4 Hotspot positioning

- To find a hotspot, aim the thermometer outside the area to be measured and then move it around within the correct area to find the hotspots.

10.5 Tips

- Not recommended for measuring on light metal or smooth metal surfaces such as stainless steel, aluminum, etc.
- Sensor cannot penetrate through transparent surfaces such as glass.
- Steam, dust, smoke, etc. block the sensor from picking up infrared energy, thus decreasing it's accuracy.

10.6 Warranty

- Clean the meter regularly with a dry cotton cloth. DO NOT use any type of chemicals or detergents.
- Maintenance and repairs should only be done by qualified personnel.
- DO NOT immerse the thermometer in water.
- DO NOT store the thermometer in an area with high temperature or high humidity.

10.7 Emissivity

- Emissivity characterizes the type material and the amount of radiant energy given off by the material. Most organic materials and painted/oxidized surfaces have an emissivity of 0.95.

11. Accessories and Table of Emissivity

11.1 Accessories

- Instruction Manual
- Warranty Card
- 9V Battery
- Type-K Thermocouple
- Hook

11.2 Table of Emissivity

Material	Emissivity	Material	Emissivity
Aluminum	0.30	Glass	0.90 to 0.95
Asphalt	0.95	Iron Oxides	0.78 to 0.82
Concrete	0.95	Paint	0.80 to 0.95
Asbestos	0.95	Plastic	0.85 to 0.95
Ceramics	0.95	Paper	0.70 to 0.94
Brass	0.50	Plaster	0.80 to 0.90
Brick	0.90	Rubber	0.95
Carbon	0.85	Wood	0.90
Sludge	0.94	Textile	0.94
Frozen Food	0.90	Lead	0.50
Hot Food	0.93	Marble	0.94
Ice	0.98	Cloth (black)	0.98
Snow	0.90	Sand	0.90
Human Skin	0.98	Water	0.93

