

twilight

INSTRUMENTOS DE MEDICIÓN INDUSTRIAL

Detector Ultrasónico de Fallas Rango Avanzado 0 a 10000 0 mm

DE-DFD20

www.twilight.mx

 / [twightsadecv](https://www.facebook.com/twightsadecv)

 / [twightsadecv](https://twitter.com/twightsadecv)

 / [twightsadecv](https://www.youtube.com/twightsadecv)

Ultrasonic Flaw Detector DFD20

Operation Instructions



Dragon Electronics Co.

Content

Chapter I Overview.....	4
1.1 How to Use the Operation Instructions.....	4
1.2 Standard Configurations and Options.....	5
Chapter II Technical Parameters and Performance Features of the Instrument	6
2.1 Measuring Range and Measuring Error.....	6
2.2 Operation Environment	6
2.3 Power supply	6
2.4 Overall Dimension and Weight.....	6
2.5 Performance Features	7
2.6 Technical Parameters	7
Chapter III Operation.....	10
3.1 Overview of the Instrument	10
3.2 Operation	12
Chaper IV Description of functions and operation way	20
4.1 Adjustment of BASE Group	20
4.2 Adjustment of PROBE Group	22
4.3 Adjustment of setting.....	25
4.4 Adjustment of MEM Group.....	27
4.5 Adjustment of GATE Group.....	29
4.6 Auto C (Automated calibration of transducer).....	32
4.7 Adjustment of DAC1 Group.....	35
4.8 Adjustment of DAC2 Group.....	38
4.9 Adjustment of AVG1 Group	40
4.10 Adjustment of AVG2 Group.....	42
4.11 Adjustment of Pulse Group.....	43
4.12 Adjustment of GAIN Group	44
4.13 Adjustment of B / V Group.....	45
4.14 Adjustment of CFG1 Group	47
4.15 Adjustment of CFG2 Group.....	49
4.16 AWS Group	50
4.17 Adjusting of Special Functions.....	52
Chapter V Calibrating the Instrument and Measuring	55
5.1 Calibrating of Single Probe.....	55
5.2 Calibrating of Double Probe.....	57
5.3 Calibrating of Angle Beam Probe.....	58
5.4 Application of DAC Curve.....	59
5.5 Contents of Measurement	60
Chapter VI Communication for the Instrument	62

6.1 Data Communication	62
Chapter VII Maintenance and Repairing	63
7.1 Requirement on Environment	63
7.2 Charging the Battery	63
7.3 Troubleshooting	63
7.4 Tips on Safety	64
Appendix	65
Appendix I Notice to User	65
Appendix II List of Operations	66
Appendix III 6dB DAC CURVE SETTING STEPS	68
Appendix IV Terms	70

Chapter I Overview

This is a portable industrial non-destructive flaw detector, which can rapidly, easily and accurately inspect, locate, evaluate and diagnose various defects (crack, inclusion and pinhole, etc.) in a workpiece without destruction. It can be used both in a lab and field. The instrument can be widely used in any fields that need defect inspection and quality controlling e.g. manufacturing industry, iron & steel metallurgical industry, metalworking, chemical industry, etc., also be broadly used in the active safety inspection and service-life evaluation in such fields as aerospace, railway transportation and boiler pressure vessels, etc. It is an essential instrument for non-destructive inspection industry.

When the ultrasonic wave propagates in a job, one can detect the defect in it by the influence on the propagation of ultrasonic wave based on the acoustic characteristic demonstrated by the defect in the material. Based on this principle, by using ultrasonic wave one can measure such defects as crack, pinhole and inclusion in such media as metal, non metal and composite, etc.

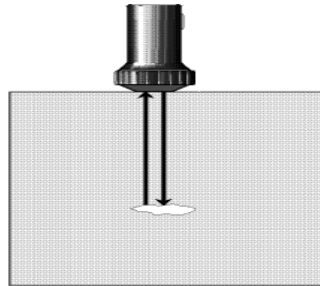

Fig. 1.1 Basic working principle for ultrasonic detection

1.1 How to Use the Operation Instructions

It is necessary to read chapter 1, 2, 3 and 4 of the Instructions before operating instrument for the 1st time. The descriptions in the chapters are necessary preparation for operating the instrument, which will describe all keys and displays on screen, and explain the operation principle.

By following the directions, you can avoid error or failure due to operation mistake and can have a clear concept about all functions of the instrument.

1.1.1 Layout of Pages and Conventions of Expressions

In order that you can use the Instructions easily, all operation steps and matters needing attention are arranged in a consistent way. This is helpful for getting independent information. The structure of Contents for the Instructions is as deep as up to the 4th level, and the items after the 4th level will be indicated in bold titles.

Signs for Notes and Remarks

Note: the sign of “Note” indicates the features and special aspect that may influence the accuracy of result during operation.

Remarks: explanation, may include reference to other chapters or special introduction on a certain function.

List of item

The list of item is expressed in the following way

Item A

Item B

...

Operation procedure

The expressing way for operation procedure is as that shown in the following example

- By <Page up> key switch the function page.
- By <F1> key you select **BASE** functional group, and by <Menu> key, you select the functional menu for **RANGE**, and then adjust parameters for **RANGE** by key + or - .
- You can shift the Rough and Fine adjusting mode by Enter key .

1.2 Standard Configurations and Options

1.2.1 Standard Configuration

Table 1.1 List of standard configurations

Designation	Quantity
Main unit	1
1.5A/9V power adaptor	1
probe connecting cable	2
Carrying case	1
Instruction manual	1
Straight probe	3/4" 2.5MHz (One)
Angle probe	8×9 60° 4MHz (One)

1.2.2 Options

Table 1.2 List of options

Designation	Quantity
-------------	----------

Designation	Quantity
Serial cable	1 (9 pin)
Communication software for PC	1 set

Chapter II Technical Parameters and Performance Features of the Instrument

2.1 Measuring Range and Measuring Error

Range of scanning:	0 mm ~10000 mm
Resolution for scanning:	0.1mm (2.5mm ~100mm) 1mm (100 mm ~10000mm)
Range of gain:	0dB ~120 dB
D-Delay:	-20 μ s ~ +3400 μ s
P-Delay:	0 μ s ~ 99.99 μ s
Sound speed :	1000 m/s ~ 15000m/s

2.2 Operation Environment

Temperature:	-20°C~50°C
Humidity:	20% ~ 90%RH
Free of strong magnetic field and corrosion.	

2.3 Power supply

Li battery 7.4V 4800mAh

2.4 Overall Dimension and Weight

Overall dimension:	240mm×150mm×50mm
Weight:	1.6kg

2.5 Performance Features

- Automated calibration of transducer Zero Offset and/or Velocity ;
- Automated gain、 Peak Hold and Peak Memory;
- Automated display precise flaw location(Depth d、 level p、 distance s、 amplitude、 sz dB、 ϕ);
- Automated switch three staff gauge ((Depth d、 level p、 distance s);
- **300 independence setup, any criterion can be input freely, we can work in the scene without test block;**
- Big memory of 800 A graph.
- Gate and DAC alarm; Acoustic-Optical alarm;
- USB port, communication with pc is easy;
- The embeded software can be online updated;
- **Li battery, continue working time up to 10 hours;**
- There are 14 standards of DAC in DFD20.
- Display freeze;
- Automated echo degree;
- Angles and K-value;
- Lock and unlock function of system parameters;
- Electronic clock calendar ;
- Two gates setting and alarm indication;
- High-speed capture and very low noise;
- **DAC、 AVG、 TCG、 B Scan ; Solid metal housing (IP65);**
- Automated calculate the size of the flaw with wide bottom type in AVG function.
- **6dB DAC functions;**
- Provides high contrast viewing of the waveform from bright, direct sunlight to complete darkness and easy to read from all angles;
- Powerful pc software and reports can be export to excel;

2.6 Technical Parameters

Designation	Technical Data
Range of scanning (mm)	Range of scanning (mm): 0 ~ 10000 Steps: 2.5,5,10,20, 30,40,50,60,70,80,90, 100,150,200, 250, 300, 350, 400, 450,500,600,700,800,900,1000,2000,3000,4000,5000,6000,7000,8000,10000 Adjusting step: 0.1mm (2.5 mm ~ 99.9mm), 1mm (100mm ~ 10000mm)

D-delay (μs)	D-delay (μs): -20 ~ +3400 Steps: -20,-10,0.0, 10, 20, 50,100,150,200,250,300,350,400,450,500, 600, 700,800,900,1000,1500,2000,2500,3000,3400. Adjusting steps: 0.1 (-20 μs ~ 999.9 μs), 1 (1000 μs ~ 3400 μs)
P-delay (μs)	P-delay: 0.0 ~ 99.99 Adjusting steps: 0.01
MTLVEL (m/s)	MTLVEL: 1000 ~ 15000 10 fixed levels: 2260,2730,3080,3230,4700,5920,6300,12000,13000,14000,15000 Adjusting steps: 1
Working mode	Single probe (receiving and sending), double probe (one for receiving and another for sending), transmission (transmission probe)
Frequency Range (MHz)	0.5~20
Gain adjustment (dB)	0 ~ 120 Adjusting step: 0.0, 0.1, 0.5, 1, 2, 6, 12
Reject	0% ~ 80% of screen height, step: 1%
Vertical linear error	Vertical linear error is not more than 3%
Horizontal linear error	Not more than 0.2% in the scanning range
Sensitivity Leavings	≥ 62 dB
Dynamic range	≥ 34 dB
Alarm	Three modes, i.e. forbidden wave, loss wave and auto
A-Scan display area	Full screen or local A-Scan display freezing and de-freezing A-Scan filling
Data save	800 A-Scan images (including setting of instrument)
Standard communication interface with PC	USB
Measuring unit	mm/inch
Battery	Li battery 7.4V 4800mAh

Power adaptor	Input 100V~240V/50Hz~60Hz Output 9VDC/1.5A
Working temperature	-20°C ~ 50°C
Working humidity	20%~90%
Port type	LEMO 1
Overall dimension (mm)	240×150×50
Weight (kg)	1.6

Chapter III Operation

3.1 Overview of the Instrument

3.1.1 Designation of the Instrument's Components

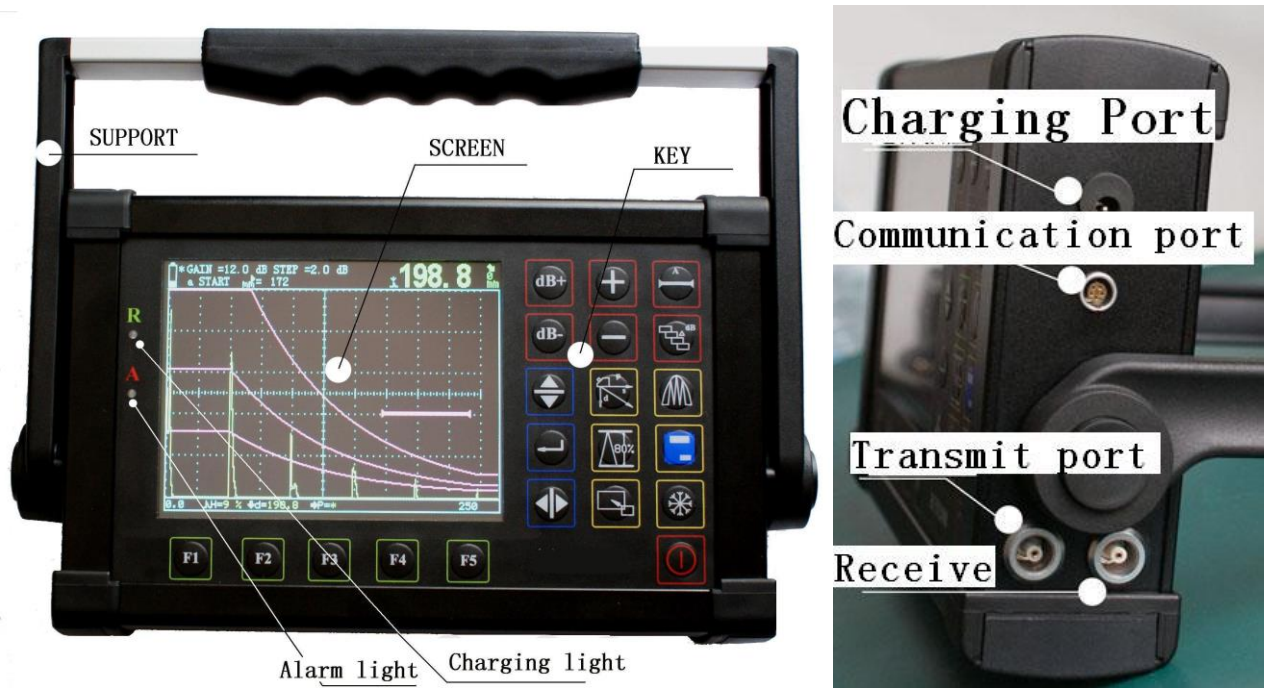









Fig.3.1 Outside Drawing of the Instrument

3.1.2 Functional Keyboard

Keys of DFD20 are included in three groups: Function group, usual key group and special function group. There are 6 keys in Functional group, in which F1, F2, F3, F4, F5 are corresponding with the 5 functional groups on screen, and the key \diamond is used for switching of pages; Usual key group comprises 9 key: Up,down, dB+, dB-,+,-, gain step key , freeze key , Enter key. they are used for usual operating; and special function group consists of 9 keys: on/off key, full screen key , detection zone ,gate A,gate B,Auto gain , peak memory  and measure display . Overall arrangement of the whole face is as following picture.Overall arrangement of the whole face is as following picture.:

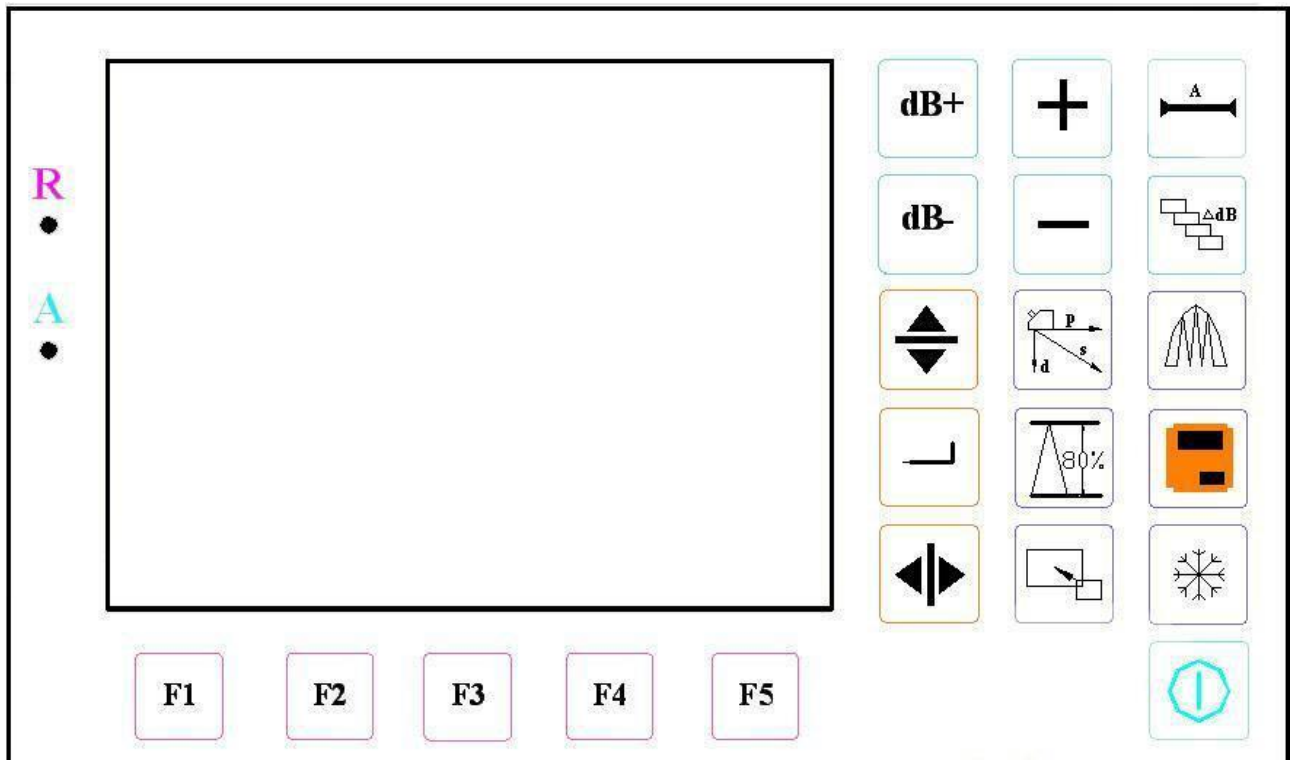

Fig.3.2 Functional Keyboard

Particular Operation Instructions of keys refer to appendix II.

3.1.3 Using of Power Supply

DFD20 can work with plug-in power supply (AC, DC adaptor) or battery.

The detector will switch the power supply to adapter automatically when the power supply adaptor is used.

The detector will switch the power supply to battery automatically when the power supply adaptor is turned off.

The batteries will be charged automatically When DFD20, which is equipped with battery , is power supplied with adapter.

3.1.4 Working with Battery

Indicator for charging

At higher left corner of DFD20 horizontal scale, there are symbols for battery voltage:

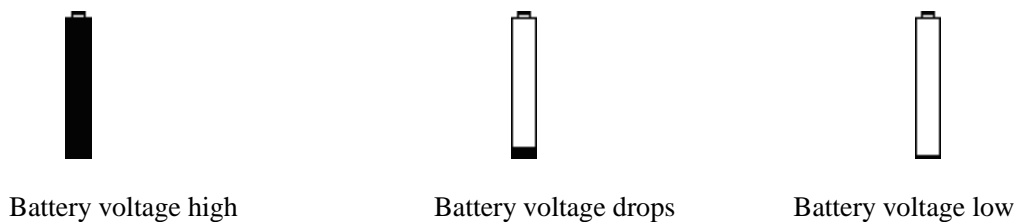

Fig.3.3 Battery status display

If it shows the symbol for low voltage, you must stop detection immediately and use adpter or charge it.



Charging the Li Battery.

You can charge the Li battery by using an external battery charger. It is recommended to charge by using the power adaptor in the standard kit of DFD20. Before using the charger, please read carefully the Operation Instructions for it. The continuous charging time for Li (4.8Ah) battery is about 4h~5h. During the charging, Rapid Charging indicator lamp (green) will light up; when the charging completes, the Rapid Charging indicator lamp goes out. .

3.1.5 Connecting the Probe

Proper probe shall be connected when using DFD20 to inspect. So long that you have a proper cable, and the working frequency is within proper range, any probe made by our company is suitable for DFD20. The probe connector for DFD20 is LEMO 1.

The probe shall be connected to the socket at top of the instrument casing. Both connector sockets have different function, sending socket at left (with red mark) and receiving socket at right (with blue mark) .With Single-Probe mode, the sending socket can be used only. When connecting a double-wafer (TR) probe (one wafer for sending, another for receiving) or two probes (one for sending, another for receiving), take care that the sending probe shall be connected to the sending socket and receiving probe to the receiving socket .Otherwise, it may result in loss or disorder echo waveform.

3.2 Operation

3.2.1 Basic steps

Select setting——>select probe type——>auto calibrate probe and other settings——>make curve (DAC、AVG) ——>save setting——>start flaw detecting

3.2.2 Starting the Instrument

press , turn on the instrument, it will carry out self test. After five seconds, the instrument come into operation mode. .

Remarks: Press “Combined Key ” as startup and loading of the program to execute some special functions, Particular Operation Instructions of Combined keys refer to appendix II.

3.2.3 Description about Screen Display

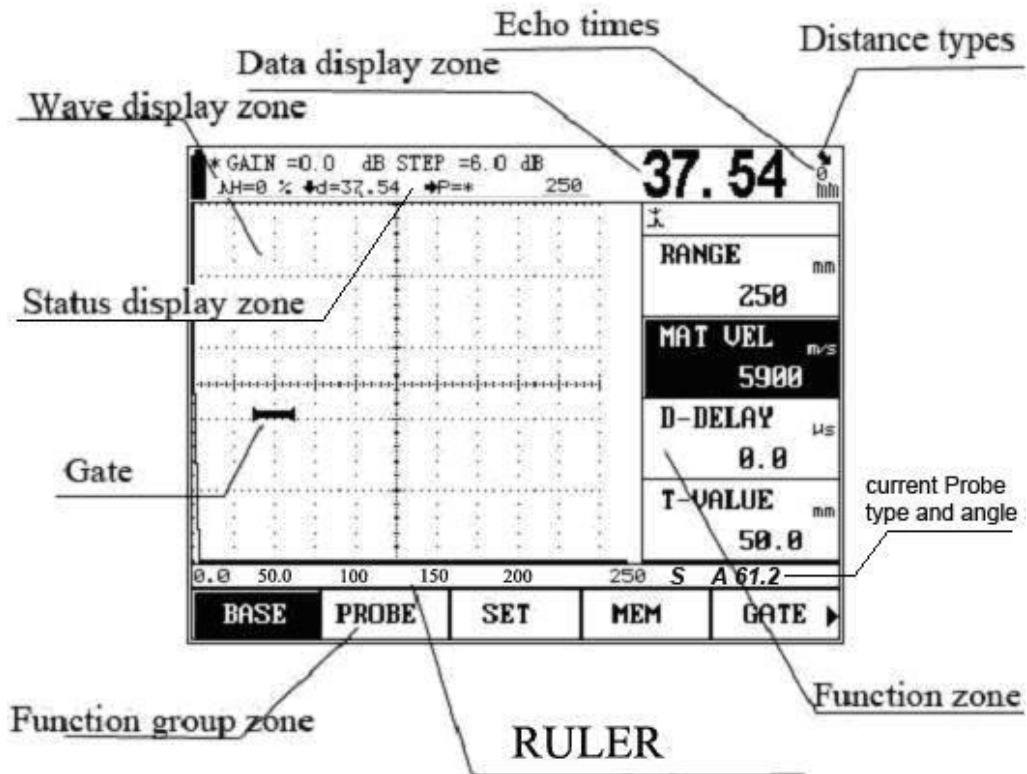

Fig. 3.4 Description about screen

3.2.3.1 Three Display Modes of DFD20 Screen,

- A-scan at normal mode

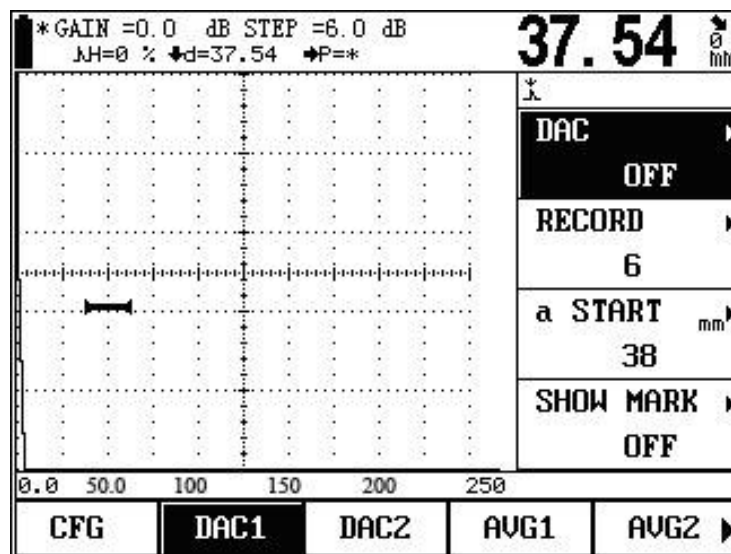



Fig. 3.5 A-scan at normal mode

- A-scan at Enlarged mode

You can activate Enlarge mode by . The gain and selected dB step value will be always displayed on the screen. And at the same time, all other functions are locked.

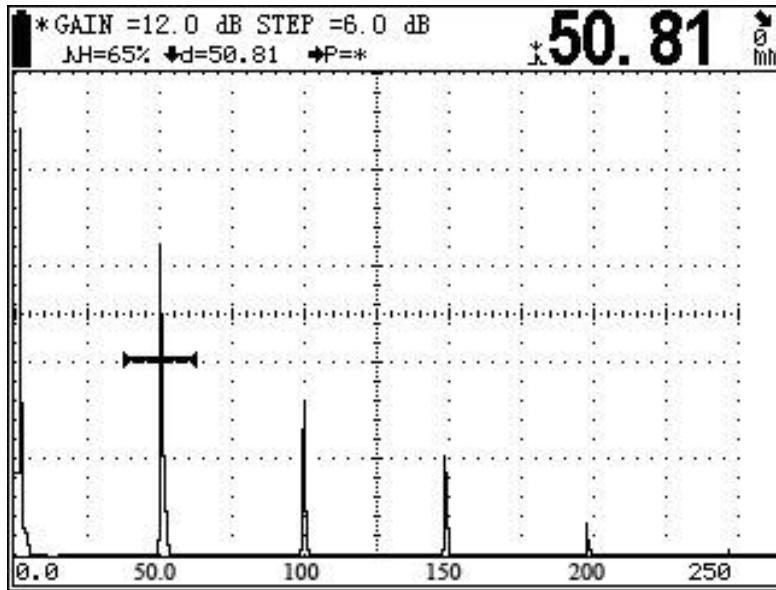

Fig. 3.6 A-scan at Enlarged mode

- Manual B-scanning

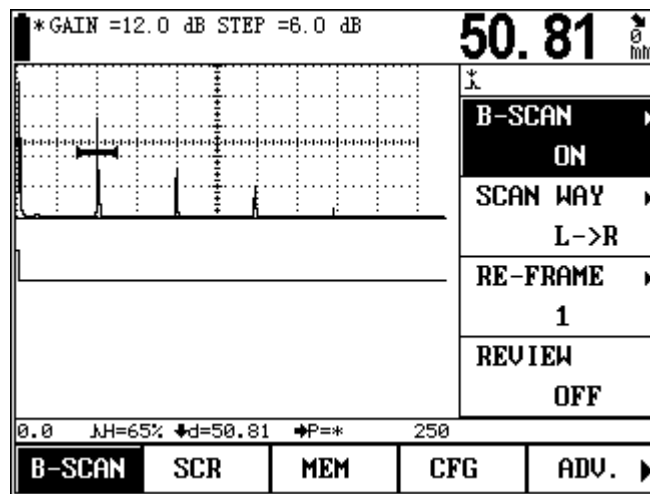
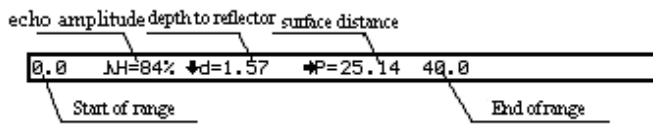

Fig. 3.7 B-scan mode

3.2.3.2 Function Displaying Items

The 16 functional groups are displayed at lower part of the screen in three pages. The current functional group will be highlighted, as that shown in fig. 3.4. and at the same time, the current function in the current functional group will also be highlighted, as that shown in fig.3.4. Under Enlarged mode, the display of functional groups disappear.

3.2.3.3 Description about Symbols Displayed on Screen



In the fig left, echo amplitude H=84%, depth to the reflector=1.57mm, surface distance=25.14mm, echo times is 2, start of range=0.0mm, end of range=40.0mm

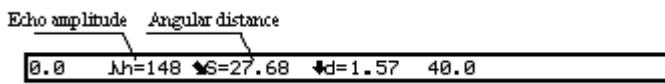

In the fig left, echo amplitude(pixels) H=148, Angular distance=27.68mm.

Fig. 3.8 Description about the display field in screen

3.2.3.4 Display of echo times

When the angle of probe is not zero and the measured echo is multi-echo, the echo times will be drew on the status column as that shown in fig.3.4.

3.2.3.5 Description about other symbol

There some other symbols above functional menu, Freeze and Communication symbol is beside the battery status symbol.

symbol	name	Description
*	Freeze	Freeze state.
!	Communication	The instruments is communicating with PC.
↗	Angular distance	distance from the incidence point to the reflecte point.
↓	Depth to reflector	depth from the incidence point to the reflecte point.
→	Surface distance	surface distance from the incidence point to the reflecte point.
⊥	Echo amplitude	The amplitude value of max echo within the gate.
⊥	Edge sampling	It show that the instrument is in “Edge sampling” mode, depth and angular distance is the measure value of the first echo which is above the gate and within the gate.
⊥	Peak sampling	It show that the instrument is in “Peak sampling” mode, depth and angular distance is the measure value of the echo with the max amplitude within the gate.
F	Memory peaks	peaks memory function is enabled.
T	Making video	Dynamic Record function is enabled.
E	Operation error	Operation error last time.
∅	Radian revise	Abscissa and measure result is revised according to radian.

3.2.4 Overview of All Functions

The functions of DFD20 are included in 16 functional groups and several special functions.

The functional groups include BASE, PROBE, SET, MEM, GATE, AUTO C, DAC1, DAC2, AVG1, AVG1, PULSE, GAIN, B/V, CFG1, CFG2,AWS they will be introduced in the following table.



No.	group	Functions	Description
1	BASE	RANGE, MTLVEL, D-DELAY , T-VALUE	Basic adjustment items necessary for the display range
1	PROBE	PROBE TYPE/ PROBE POS, ANGLE/K-VALUE , P-DELAY/ X-VALUE, X-COORD/ PART DIA	Probe adjustment items needed
1	SET	SETTING NO. , RECALL/REFACTORY、 SAVE、 DELETE/CLEAR ALL	Relative items for independence setups
1	MEM	DATA NO, RECALL, SAVE, DELETE	Setting of data memory
1	GATE	GATE LOGIC/ALARM, aSTART/bSTART, aWIDTH/bWIDTH, aTHRESH/bTHRESH	Relative items for gate configuration
2	AUTO C	CSBT, CABT, aSTART/ aWIDTH, TYPE	Automated calibration of transducer
2	DAC1	DAC/REVISE, RECORD/REVISE POS, aSTART/aWIDTH, SHOW MARK/DAC MODE	Plotting DAC curve
2	DAC2	DAC-EL/ERS-REF, DAC-SL, DAC-RL, T-KORR/JDAC	Setting relative with DAC curve
2	AVG1	AVG MODE/CHOCK VEL 、 PROBE NAME 、 FREQUENCY/DIAMETER 、 REF TYPE/REF SIZE	
2	AVG2	A START/AVG CURVE、 RECORD REF、 TEST ATTN/CORRECT	
3	Pulse	ENERGY, Pulse width	
3	Gain	REF GAIN、 ADD REF、 SCAN DB、 AUTO-80	Relative items for gain
3	B / V	B-SCAN /A-SCAN、 SCAN WAY/SCAN MODE、 REVIEW/VIDEO	
3	CFG1	DETECT/ REJECT, GRID/BRIGHTNESS, UNIT / BUZZER, DATE/TIME	
3	CFG2	LANGUAGE, COLOR SET, ABOUT	

4	AWS	INDICA/ A START、	REFRANCE、	ATTEN 、	RATING
---	-----	------------------	-----------	---------	--------

Other special functions can be realized by Special Function (SF) keys. The functions of each SF keys are introduced in the following table.

Special Functions	Description of function
Gain step	To adjust the gain step
dB+, dB-	To adjust the gain
Full-screen	To switch over in full screen
Freeze	To freeze waveform
Dynamic record	On/off Dynamic record
Memory Peaks	Capture the max value of echo on the screen
Measure display	Select the display mode of measure result on the screen
Enter	Switch of multi-menu, parameters, confirmation of functions
Page up	Switch function page

3.2.5 Basic Operation Way

You can select a functional group by <Fn> key; select certain function by <Menu> key and ; at this time, you can modify parameters of this current menu by +/- key. And for some functional menus, they are shared by two functions, when you have selected such a function, by pressing  or the corresponding <Menu> key, it can be shifted to another function.

3.2.5.1 Selection of Functions

There are 5 functional groups displayed below the A-scan zone, which can be selected by the corresponding <Fn> key, and the selected one will be highlighted. The four corresponding function items will be displayed closely next to the right of A-scan zone, which can be selected by press “↑” or “↓” key key.

3.2.5.2 Multipurpose Function Items

In some cases, a functional item has two functions. thus they can be shifted by pressing down the press “↑” or “↓” key key again or striking  key. The symbol “>” displayed behind the function name means that it is a multipurpose function item.

Function I	Function II	Functional group to which
GATE LOGIC	ALARM	GATE
aSTART	bSTART	GATE
aWIDTH	bWADTH	GATE

aTHRESH	bTHRESH	GATE
ANGLE	K-VALUE	PROBE
X-VALUE	X-COORD	PROBE
PROBE POS	PART DIA	PROBE
RECORD	REVISE POS	DAC1
aSTART	aWIDTH	DAC1
SHOW MARK	DAC MODE	DAC1
DAC-RL	ERS-REF	DAC2
AVG MODE	CHOCK VEL	AVG1
FREQUENCY	DIAMETER	AVG1
REF TYPE	REF SIZE	AVG1
A START	AVG Curve	AVG2
CORRECT	TEST ATTN	AVG2
B-scan	A-scan	B/V
SCAN WAY	SCAN MODE	B/V
RE-FRAME	RE-SPEED	B/V
ABOUT	COLOR SET	CFG2
DATA NO (for Wave)	DATA NO	MEM
COORDINATE	BRIGHTNESS	CFG1
UNIT	BUZZER	CFG1
DATE	TIME	CFG1

3.2.5.3 Rough and Fine Adjustment of Functions

For some functions, rough and fine adjustment are available. By pressing down the corresponding  key, you can shift between these two adjusting modes. With a symbol “*” in front of the function item that means it is in fine adjustment mode.

The following are the functional items with optional rough and fine adjustment

Functions	Functional group
RANGE	BASE
MTLVEL	BASE
D-DELAY	BASE
T-VALUE	BASE

3.2.5.4 Example of Function Operation:

Suppose that the function of **RANGE** in **BASE** functional group is selected currently, and you want to select **ALARM** under **GATE**, what to do?

Firstly Select the **GATE** group by the key <F5>, and then select **GATE LOGIC/ALARM** functional menu by “↑” or “↓” key. this functional menu is multipurpose gate logic and alarm way, so user has to shift the two functions as he needs. if it displays **ALARM** way, the operation completes; if it displays **GATE LOGIC**, shift it to **GATE LOGIC** way by key , and now the operation of function selection is completed.

Chaper IV Description of functions and operation way

4.1 Adjustment of BASE Group

In the BASE functional group, users can adjust and set the functional items relative with the display range, including RANGE, MTLVEL, D-DELAY and T-VALUE.

During the detection, the display range of screen is in great relation to the material of workpiece and probe's nature. The workpiece material will influence the transmission velocity of ultrasonic wave.

Remarks: *In order to set the sound velocity of ultrasonic wave in workpiece and P-DELAY, Do please refer to Chapter V Calibration of Instrument.*

4.1.1 Detection Range (RANGE)

It is to set the measuring range for screen display during detection

Range: 0mm ~ 1000mm/0.1 " ~ 200 "

If what selected currently is RANGE functional menu, then by pressing , it is allowed to shift between Rough and Fine adjustment.

Rough adjustment: 2.5mm, 5mm, 10mm, 20mm, 30mm, 40mm, 50mm, 60mm, 70mm, 80mm, 90mm, 100mm, 150mm, 200mm, 250mm, 300mm, 350mm, 400mm, 450mm, 500mm, 600mm, 700mm, 800mm, 900mm, 1000mm, 2000mm, 3000mm, 4000mm, 5000mm, 6000mm, 7000mm, 8000mm, 9000mm, 10000mm

Fine adjustment:	Range	Step graduation
	≤100.0mm	0.1mm
	>100mm	1mm

Operation:

- By <Page up> key, switch the function page.
- Select BASE functional group by <F1> key, and by “↑” or “↓” key, select the functional menu for RANGE, and then adjust parameters for RANGE by “+” or “-” key.
- Users can shift the Rough and Fine adjusting mode by key .

4.1.2 Material velocity (MTLVEL)

Users are allowed to set the transmission velocity of ultrasonic wave in workpiece.

Range: 1,000m/s ~ 15000m/s or 0.0394in/μs ~ 0.3937in/μs

If what selected currently is **MTLVEL** function menu, then by the key $\overline{\text{↵}}$, it is allowed to shift between Rough and Fine adjustment.

Rough adjustment:

2,260m/s	0.089 in /μs	Sound velocity of transverse wave in copper
2,730m/s	0.107 in /μs	Sound velocity of longitudinal wave in organic glass
3,080m/s	0.121 in /μs	Sound velocity of transverse wave in aluminum
3,230m/s	0.127 in /μs	Sound velocity of transverse wave in steel
4,700m/s	0.185 in /μs	Sound velocity of longitudinal wave in copper
5,900m/s	0.233 in /μs	Sound velocity of longitudinal wave in steel
6,300m/s	0.248 in /μs	Sound velocity of longitudinal wave in aluminum

Fine adjustment: Step is 1m/s or 0.0001in/μs

Operation:

- By <Page up> key, switch the function page.
- Select **BASE** functional group By <F1> key, and by “↑” or “↓” key, select the functional menu for **MTLVEL**, and then adjust parameters for **MTLVEL** by “+” or “-” key.
- Users can shift the Rough and Fine adjusting mode by Enter key $\overline{\text{↵}}$.

Remarks: Do guarantee the correctness of sound velocity (level), because partial measuring results displayed in the status lines of the instrument are calculated based on the sound velocity.

4.1.3 Display starting point (D-DELAY)

Can set the pulse shift during detection, viz. D delay. By which, users are allowed to adjust the starting position for waveform, as well as adjusting the zero point of pulse, so as to make sure that it is at the surface or a starting face inside the workpiece. If the pulse has to be started from the surface of workpiece, D delay must be set to 0.

Range: -20μs ~ 3400μs

Step: 0.1μs

Operation:

- By <Page up> key, switch the function page.
- Select **BASE** functional group by <F1> key, and by “↑” or “↓” key, select the functional menu for **D-DELAY**, and then adjust parameters for **D-DELAY** by “+” or “-” key.
- Users can shift the Rough and Fine adjusting mode by key $\overline{\text{↵}}$.

4.1.4 Thickness of workpiece (T-VALUE)

It is to set the thickness of workpiece during detection.

Thickness range: 1mm ~ 1000mm

Rough and Fine adjustment can be switched by the key .

Rough adjustment: 5 mm, 10 mm, 20 mm, 50mm, 100mm, 200mm, 300mm, 400mm, 500mm, 600mm, 700mm, 800mm, 900mm and 1000mm

Fine adjustment: 0.1mm <100 mm
1mm >100 mm

Operation:

- By <Page up> key switch the function page.
- By <F1> key select **BASE** functional group, and by “↑” or “↓” key, select the functional menu for **T-VALUE**, and then adjust the job’s thickness by “+” or “-” key.

Users can shift the Rough and Fine adjusting mode by Enter key .

4.2 Adjustment of PROBE Group

With this functional group, it is allowed to adjust and set the functional items in relation to ultrasonic sending and receiving, including PROBE TYPE/ PROBE POS, ANGLE/K-VALUE , P-DELAY/ X-VALUE, X-COORD/ PART DIA

4.2.1 PROBE TYPE/ PROBE POS

This menu is multipurpose for setting probe type and probe pos. By key  , shift between probe type and probe pos.

PROBE TYPE:

Setting of ultrasonic probe. If the current probe is an echo probe, then set it to single (straight or angle); if it is a double-wafer probe, set it to DUAL, and if it is a through transmission probe, set it to THRU.

Options: STRAIGHT: Single straight element transducers. Use connector acts as a transmitter (T)

ANGLE : Angle straight element transducers. Use connector acts as a transmitter (T)

DUAL: Daul element transducers. One connector acts as a transmitter (T), the other acts as a receiver (R).

THRU: Two separate transducers, typically on opposite sides of the test specimen. Use the T transducer connector as the transmitter. The R transducer connector is designated as the receiver.

Operation procedure:

- By <Page up> key switch the function page.
- By <F2> key select **PROBE** functional group, and by “↑” or “↓” key, select the functional menu for **PROBE TYPE**, and then adjust parameters for **PROBE TYPE** by “+” or “-” key.

PROBE POS:

Select position of probe when we detect a pipe.

Options: Outside surface: Probe is placed on the outside surface of pipe, Now, the corrected d value show the depth of the flaw from the outside surface of pipe, L value show the distance between flaw and probe front edge follow outside surface.

Inside surface: Probe is placed on the inside surface of pipe, Now, the corrected d value show the depth of the flaw from the inside surface of pipe, L value show the distance between flaw and probe front edge follow inside surface.

Operation:

- By <Page up> key switch the function page.
- By <F2> key select **PROBE** functional group, and by “↑” or “↓” key, select the functional menu for **PROBE POS**, and then select probe position by “+” or “-” key.

4.2.2 Probe Angle (ANGLE)/Probe K Value (K-VALUE)

- This menu is multipurpose for setting probe angle and probe k value. By key  , shift between **ANGLE** and **K-VALUE**.

ANGLE:

It is to adjust the angle of a probe.

Range: 0.0° ~ 89.0°

Step: 0.1°

Operation:

- By <Page up> key switch the function page.
- By <F2> key select **PROBE** functional group, and by “↑” or “↓” key, select the functional menu for **ANGLE**, and then adjust the probe angle by “+” or “-” key.

K-VALUE:

Range: 0.00 ~ 57.29

Step: 0.01

Operation:

- By <Page up> key switch the function page.
- By <F2> key select **PROBE** functional group, and by “↑” or “↓” key, select the functional menu for **K-VALUE**, and then adjust the probe k value by “+” or “-” key.

4. 2. 3 P-DELAY/ X-VALUE

- This menu is multipurpose for setting p-delay and x-value. By key  , shift between P-DELAY and X-VALUE.

P-DELAY:

Can set the zero point of probe during detection, viz. P Delay. It is necessary to compensate the delay in probe resulted from acoustic beam in the pitch interval from energy exchanger to workpiece by P Delay.

Range: 0 μ s ~ 99.99 μ s

Step graduation: 0.01 μ s

Operation:

- By <Page up> key, switch the function page.
- Select PROBE functional group By <F2> key, and by “ \uparrow ” or “ \downarrow ” key, select the functional menu for P-DELAY, and then adjust parameters for P-DELAY by “+” or “-” key.

Remarks: If P Delay is unknown, please do refer to Chapter V Calibration of Instrument.

X-VALUE:

It is to set the front edge of probe.

Range: 0.00mm ~ 50.0mm

Step: 0.01mm

Operation:

- By <Page up> key switch the function page.
- By <F2> key, select PROBE functional group, and by “ \uparrow ” or “ \downarrow ” key, select the functional menu for X-VALUE, and then adjust the probe front edge by “+” or “-” key.

4. 2. 4 X-COORD/ PART DIA

This menu is multipurpose for setting X-COORD and PART DIA. By key  , shift between X-COORD/ PART DIA.

X-COORD:

Coordinate mode means the definition of the horizontal coordinate line, including “S-PATH” “P-VAL” and “DEPTH”, when the refraction angle is not zero, the function above is effective, when it is zero, the coordinate is defined as S-PATH.

Options: S-PATH, P-VAL, DEPTH

Operation:

- By <Page up> key switch the function page.
- By <F2> key select PROBE functional group, and by “ \uparrow ” or “ \downarrow ” key, select the functional menu for

X-COORD, and then adjust the coordinate mode by “+” or “-” key.

PART DIA:

When we detect a pipe, we must input the outside diameter of part and thickness exactly. Part diameter is the outside diameter of pipe.

Range: 5.0mm~5000mm

Step: <100 mm 0.1mm

>100 mm 1.0mm

Operation:

- By <Page up> key switch the function page.

By <F2> key select **PROBE** functional group, and by “↑” or “↓” key, select the functional menu for PART DIA, and then adjust diameter value by “+” or “-” key.

4.3 Adjustment of setting

Setting Group is used for Operations of detection setting.. It includes **SETTING**, **RECALL/REFACTORY**, **SAVE ,DELETE/CLEAR ALL**

4.3.1 Detection Setting (SETTING)

SETTING:

During the detecting in scene, users usually need to do the detection on several kinds of work piece or change the probe, thus they need to calibrate the instrument time after time. To solve this problem, 100 detecting settings are available in DFD20. Users can set 300 different settings and save them, switch among the settings when it needed. When choose the different setting number, the system will use the new setting. If no customer saved setting is choose, the system will use the default setting.

Parameter range: NO.1 ~ NO.300

Operation procedure:

- By <Page up> key switch the function page.
 - By <F3> key select **SET** functional group, and by “↑” or “↓” key, select the functional menu for **SETTING**, and then adjust parameters for **SETTING** by “+” or “-” key.

4.3.2 Recall of settings (RECALL)/REFACTORY

- This menu is multipurpose for gate logic and gate alarm. Users can shift the functions for RECALL and **REFACTORY** by Enter key .

RECALL:

Recalling the setting in detection setting, when it is completed successfully, the current detection parameter setting will be replaced by the recalled one.

Operation:

- By <Page up> key switch the function page.
- By <F3> key select **SET** functional group, and by “↑” or “↓” key, select the functional menu for **RECALL**, and then carry out calling by “+” or “-” key.
- If current setting has no setting, by left an right key, this functional menu will always display OFF; if it has any setting, by “+” or “-” key, it will show “Yes/No”, if you press key  then you will call out setting, and by pressing any other key, you will cancel the calling.

REFACTORY:

Users can recover the ex-factory parameter setting when turning on the machine if necessary.

4.3.3 Saving settings (SAVE) / Modify settings (Modify)

This menu is multipurpose for Modify and **SAVE**. Users can shift the functions for Modify and **SAVE** by the <Enter> key.

SAVE:

This functional menu is for saving setting.

Operation procedure:

- Select **Setting** functional group By < F3> key, and by up/down key, select the functional menu for **SAVE**, and save the setting by “+” or “-” key..

Note: 1. A symbol “” appears before the setting number means that this setting has been set.*

2. The new setting will replace the old one in the setting which has been set before.

3. The new setting saved will not include DAC parameter setting which is auto-saved in the current setting .

4. If the current setting is locked, the saving of setting will not work.

Modify:

Modify the setting in detection setting, when it is completed successfully, the current setting will be modify by the current detection parameters.

Operation:

- Select **Setting** functional group By < Setting > key, and by up/down key, select the functional menu for **Modify**, and then recall the setting by “+” or “-” key..

4.3.4 Delete settings (DELETE) /CLEAR ALL

This functional menu is for delete setting.

DELETE:

Operation:

- By <Page up> key switch the function page.
- By <F3> key select **SET** functional group, and by “↑” or “↓” key, select the functional menu for **DELETE**, and then carry out calling by “+” or “-” key.
- If current setting has no setting, by left an right key, this functional menu will always display OFF; if it has any setting, by “+” or “-” key, it will show “Yes/No”, if you press key  then you will delete setting.

CLEAR ALL:

- By <Page up> key switch the function page.
- By <F3> key select **SET** functional group, and by “↑” or “↓” key, select the functional menu for **CLEAR ALL** and then carry out calling by “+” or “-” key.
- If all setting has no setting, by left an right key, this functional menu will always display OFF; if it has any setting, by “+” or “-” key, it will show “Yes/No”, if you press key  then you will clear all settings, and by pressing any other key, you will cancel the clear.

Note1: Use the function, all the 100 settings will be cleared, so we will be careful to do it.

4.4 Adjustment of MEM Group

This is for adjusting the memorizing modes, calling out, deleting and saving the configured data and detection parameters. It includes such functional menus as **DATA NO**, **RECALL**, **SAVE** and **DELETE**.

This instrument can memory 800 sets of data and detection parameters as well as DAC curves from A-scan,.

Note: When the MEM mode is waveform memory, the data saved includes waveform data of A-scan at that time and present detection parameters and DAC curve. This means, when calling a set of saved data, not only the waveform displayed currently will change into the waveform saved, but also current instrument's detection parameters will also change into the saved data.

4.4.1 Function group MEM (DATA NO.)

It is for setting the MEM group No. after selecting the functional menu for Group No..

Parameter range: For waveform save, 0~800

MEM mode: waveform

Operation:

- By <Page up> key switch the function page.
- By <F4> key select **MEM** functional group, and by “↑” or “↓” key, select the functional menu for **DATA NO.**, and then set group no. by “+” or “-” key..

*Remarks: Under Waveform Save mode, if * appears before group No. that means there has been data stored in; if it displays ¥ before group No., that means data has exist in this group and it has been locked;*

4.4.2 Recalling a stored data set (RECALL)

It is to recall data under Waveform Save mode, and call out the data corresponding to current group No.. When the recalling succeeds, the current waveform and detection parameters will be substituted by the saved waveform and detection parameters, and the waveform is frozen.

Operation procedure:

- By <Page up> key switch the function page.
- By <F4> key select **MEM** functional group, and by “↑” or “↓” key, select the functional menu for **RECALL**, and then carry out calling by “+” or “-” key.
- If current group no. has no data in it, by key Coder, this functional menu will always display OFF; if there is data existing in the group, by “+” or “-” key, it will show “Yes/No”, and now press the corresponding menu key or , the data will be recalled, and press any other key to cancel recalling.

4.4.3 Storing a data set (SAVE)

This functional menu is for saving data. It is to save the current waveform data into the current group no. depending on the displayed save mode. Operation:

- By <Page up> key switch the function page.
- By <F4> key select **MEM** functional group, and by “↑” or “↓” key, select the functional menu for **SAVE**, and then carry out saving by “+” or “-” key.

Note: 1. Before saving data, do make sure that there is no data in the data group corresponding to current group no, otherwise it will not work.

2. *Set the current saving mode correctly.*
 3. *If you need to upload the DAC curve to PC, please adjust the settings and DAC parameters firstly, and then save the data.*
 4. *If the current group has already got waveform data, the saving action is invalid and it will prompt with buzz.*
-

4.4.4 Deleting a data set (DELETE) /CLEAR ALL

It is to delete data. This is to delete the data corresponding to current group No. When the deletion succeeds, “*” before this group no. disappears.

Operation:

- By <Next Page > key switch the function page.
- By F4 key select **MEM** functional group, and by Up/Down key, select the functional menu for DELETE.
- If current group no. has no data in it, by the rotary knob, this functional menu will always display OFF; if there is data existing in the group, by “+” or “-” key, it will show “Yes/No”, and now press the <Enter> key, the data will be delete, and press any other key to cancel delete.

CLEAR ALL:

- By <Next Page > key switch the function page.
- By F4 select **MEM** functional group, and by Up/Down key, select the functional menu for DELETE.
- By “+” or “-” key, the menu will show “Yes/No”, if you press the <Enter> key then you will delete all datas. And by pressing any other key, you will cancel the clear.

4.5 Adjustment of GATE Group

It is used for adjustment of gate settings, including Gate logic, Gate alarm, Gate start, Gate width and Gate height.

Functions of gate during detection:

- To monitor whether the job has flaws in the set logic and range, if yes, it will alarm.
- To measure the position and size of flaw echo.

DFD20 is equipped with double-gate function: Gate A and Gate B, normally Gate A is used alone for detecting the workpiece flaw, and the double-gate is usually used in the measuring and calibration of multi-echo, eg. Measuring the distance between surface echo and first echo during thickness measurement.

4.5.1 GATE LOGIC/ ALARM

- This menu is multipurpose for gate logic and gate alarm. Users can shift the functions for **GATE LOGIC** and **ALARM** by Enter key .

GATE LOGIC:

Gate logic has four options: NONE, POS, NEG, MUL.

Options: NONE: gate monitoring is off

POS: when the echo amplitude is higher than the preset threshold of the gate, it will alarm

NEG: when the echo amplitude is lower than the preset threshold of the gate, it will alarm

MUL: state of double gates

Operation:

- By <Page up> key switch the function page.
- By <F5> key select **GATE** functional group, and by “↑” or “↓” key, select the functional menu for **GATE LOGIC**, and then adjust the gate logic by “+” or “-” key.

ALARM:

Setting of gate alarm.

It can be used for alarm of forbidden wave and loss wave depending on the setting of Gate Logic. That is, if the gate is at positive logic, when the echo amplitude is higher than the threshold, the buzzer alarms; if the gate is at negative logic, when the echo amplitude is lower than the threshold, the buzzer alarms. When the DAC is opened, the DAC-REF is instead of gate to determine alarms.

Options: ON: the buzzer is on

OFF: the buzzer is off

Operation procedure:

- By <Page up> key switch the function page.
- By <F5> key select **GATE** functional group, and by “↑” or “↓” key, select the functional menu for **ALARM**, and then turn on/off the buzzer by “←” or “→” key.

4.5.2 Starting point of the gates (aSTART/bSTART)

- This functional menu is multipurpose for Start of Gate A and Gate B. Users can shift the functions for **aSTART** and **bSTART** by key .

aSTART:

Operation procedure:

- By <Page up> key switch the function page.
- By <F5> key select **GATE** functional group, and by “↑” or “↓” key, select the functional menu for **aSTART**, and then adjust the starting position of Gate A by “+” or “-” key.

bSTART:

Operation procedure:

- By <Page up> key switch the function page.
- By <F5> key select **GATE** functional group, and by “↑” or “↓” key, select the functional menu for **bSTART**, and then adjust the starting position of Gate B by “+” or “-” key.

Remarks: Gate B is independent from Gate A. The three gate parameters: Gate Start, Gate Width and Gate Height can be adjusted separately without disturbing each other.

4.5.3 Width of the gates (aWIDTH/bWIDTH)

This functional menu is multipurpose for Width of Gate A and Gate B, when this menu is selected, by  you can shift the two functions.

aWIDTH:

Operation procedure:

- By <Page up> key switch the function page.
- By <F5> key select **GATE** functional group, and by “↑” or “↓” key, select the functional menu for **aWIDTH**, and then adjust the width of Gate A by “+” or “-” key.

bWIDTH:

Operation procedure:

- By <Page up> key switch the function page.
- By <F5> key select **GATE** functional group, and by “↑” or “↓” key, select the functional menu for **bWIDTH**, and then adjust the width of Gate B by “+” or “-” key.

4.5.4 Response and measurement threshold (aTHRESH/bTHRESH)

This functional menu is multipurpose for Threshold of Gate A and Gate B, when this menu is selected, by  you can shift the two functions.

a THRESH:

It is to set the threshold of Gate A. The parameter is expressed in percentage, i.e. the percentage in relative to the full amplitude.

Parameter range: 2% ~ 90%

Operation procedure:

- By <Page up> key switch the function page.
- By <F5> key select **GATE** functional group, and by “↑” or “↓” key, select the functional menu for **aTHRESH**, and then adjust the threshold of Gate A by “+” or “-” key.

bTHRESH:

It is to set the threshold of Gate B. The parameter is expressed in percentage, i.e. the percentage in relative to the full amplitude.

Parameter range: 2% ~ 90%

Operation procedure:

- By <Page up> key switch the function page.
- By <F5> key you select **GATE** functional group, and by “↑” or “↓” key, you select the functional menu for **bTHRESH**, and then adjust the threshold of Gate B by “+” or “-” key .

4.6 Auto C (Automated calibration of transducer)

4.6.1 Calibration of straight probe (CSBT)

For the convenience of user’s calibration of probe zero point and sound speed of material, the function of calibration is built in the gauge. Further more, users can also do the calibration of probe as what is shown in chapter 5. Straight probe can be calibrated with the following method.

For example of the standard straight probe which is frequency 2.5MHz, diameter 20mm and single. Two test blocks which are the same material with the measured object, and thickness determinate are needed.

Suppose that the probe is calibrated with two test blocks whose thickness are 50mm and 100mm, the operation steps are as following:

- (1) set the sound speed value to 5900 approximately, and set the zero value of probe to 0.00us;
- (2) adjust the gate logic to single gate;
- (3) adjust the detecting range to make the echo over 100mm can be displayed on the screen;
- (4) couple the probe on the thin test block(50mm), move gate A start to echo and cut with it.
- (5) Select the probe calibration menu in group PROBE, confirm the sound distance, then the gauge will adjust the gain automatically to make amplitude of the largest echo in gate equal 80% of the screen, and at the same time, a number appears in the probe calibration menu, adjust this number to make it the same with actual S-PATH of test block, that is 50mm.
- (6) Couple the probe on the thick test block(100mm), move gate A start to echo and cut with it.
- (7) Select the probe calibration menu in group PROBE, confirm the sound distance, then the gauge will adjust the gain automatically to make amplitude of the largest echo in gate equal 80% of the screen, and at the same time, a number appears in the probe calibration menu, adjust this number to make it the same with actual S-PATH of test block, that is 100mm.
- (8) Press the ENTER key to confirm and finish the calibration, now the material sound speed and probe zero point of gauge will get to accurate value automatically.
- (9) Before step 8, the key <FREEZE> can be used to cancel calibration.

Note: 1. the function of auto-calibration can also be used in a single thickness determinate test block. Users can do that by repetitious echoes, moving gate A to each echo and entering the correct thickness value.

4.6.2 Calibration of angle probe (CABT)

For the convenience of user's calibration of probe angle、front edge、zero point and sound speed of material, the function of calibration is built in the gauge. Further more, users can also do the calibration of probe as what is shown in chapter 5.Angle probe can be calibrated with the following method. Before calibration ,you must select type of calibration, **IIW TYPE2** and **Two holes**.

1. IIW TYPE2

For example of the standard angle probe which is frequency 4MHz, wafer 8mm×9mm , single and angle 60°.

We can use CSK-IA block to calibrate angle probe.The unit will auto adjust range and gates for you.

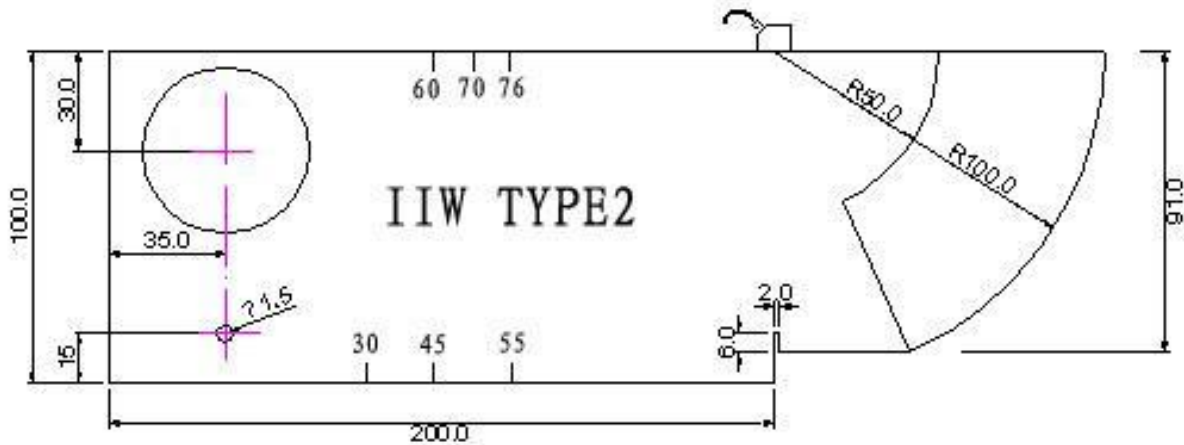

Fig.4.1 50/100 echo

- (1) Select the CABT menu in group Auto C, by you can see 50/100 echo, then put your probe as fig4.1. Try to find the highest echo of 100, then press twice, the zero point and sound speed of material has been calibrated. then press , you will see x (front edge)=XXX.XXmm, please read it and input it.
- (2) By you can see ANG echo, Then put your probe as fig4.2, Try to find the highest echo of the hole (φ 50), then press , you will see ANG=XXX.X.

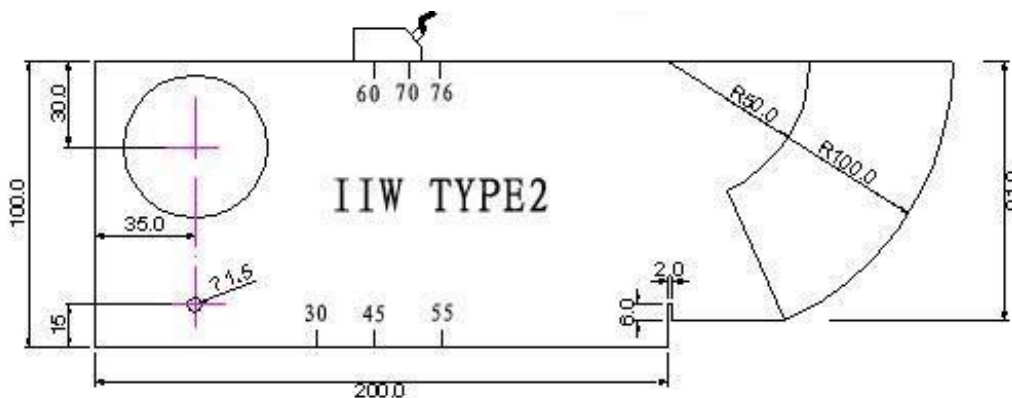

Fig.4.2 ANG ECHO

2. Two holes (no in DFD20)

For example of the standard angle probe which is frequency 4MHz, wafer 8mm×9mm , single and angle 60°.

We can use CSK-IIIA block to calibrate angle probe.

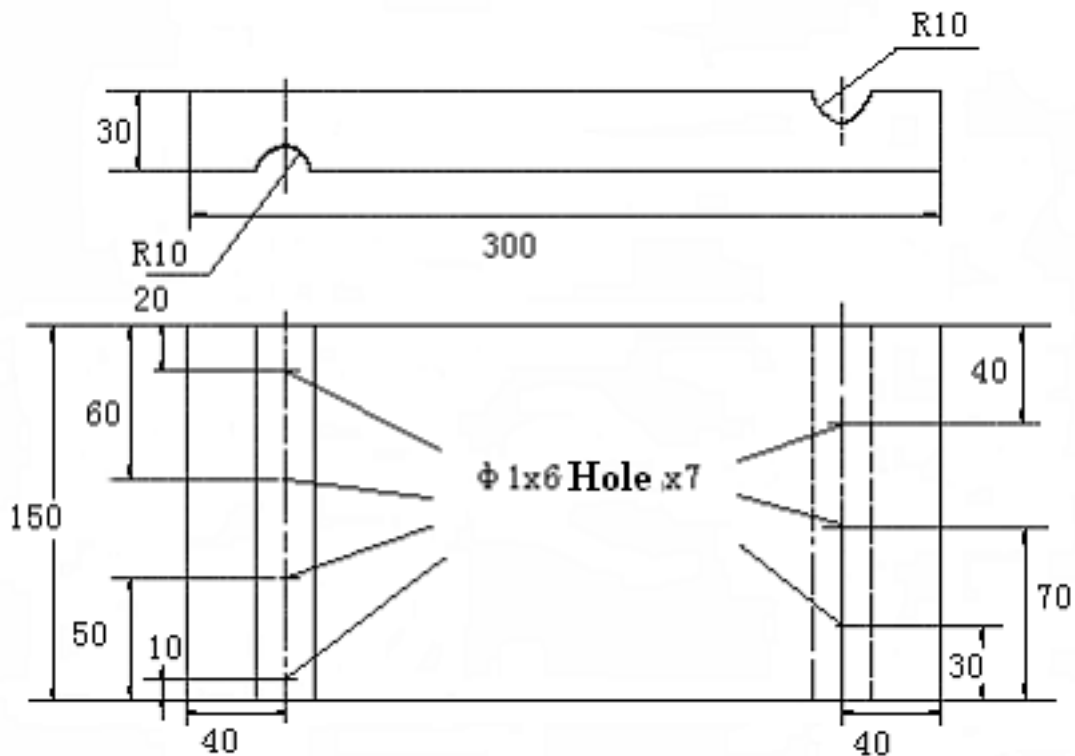

Fig.4.3 CSK-III A

Suppose that the probe is calibrated with two holes whose depth are 20mm and 40mm, the operation steps are as following:

- (3) set X-value to 0, and set the zero value of probe to 0.00us;
- (4) set the sound speed value to 3230 approximately, and set Angle-value to 60°.
- (5) adjust the gate logic to single gate;
- (6) adjust the detecting range to make the echo over 100mm can be displayed on the screen;
- (7) couple the probe on the block to find the echo from the hole whose depth is 20mm, move gate A start to echo and cut with it.
- (8) Select the CABT menu in group Auto C, confirm the sound distance, then the gauge will adjust the gain automatically to make amplitude of the largest echo in gate equal 80% of the screen, and at the same time, a number appears in the probe calibration menu, adjust this number to make it the same with actual depth of hole, that is 20mm.
- (9) Measure the distance between horizontal projection of hole and probe front, press the enter key, at the same time, a number appears in the probe calibration menu, adjust this number to make it the same with actual depth of hole, that is 29mm.
- (10) couple the probe on the block to find the echo from the hole whose depth is 40mm, move gate A start to echo and cut with it.

- (11) Confirm the sound distance, then the gauge will adjust the gain automatically to make amplitude of the largest echo in gate equal 80% of the screen, and at the same time, a number appears in the probe calibration menu, adjust this number to make it the same with actual depth of hole, that is 40mm.
- (12) Measure the distance between horizontal projection of hole and probe front, press the enter key, at the same time, a number appears in the probe calibration menu, adjust this number to make it the same with actual depth of hole, that is 69mm.
- (13) Press the ENTER key to confirm and finish the calibration, now probe angle, front edge, the material sound speed and probe zero point of gauge will get to accurate value automatically.

Before step 11, the key <FREEZE> can be used to cancel calibration.

4.6.3 Starting of the A gate (a START) / Width of the A gate (a WIDTH)

This menu is multipurpose for Start of Gate A and Width of the gate A, the reason for setting Gate A here again is to make it easy for DAC recording under manual mode; by , shift the two functions, for details please refer to 4.5.2 and 4.5.3 for operation.



4.6.4 TYPE (Types of calibration)

IIW TYPE2 and **Two holes**. Two kinds of calibration is only different for angle probe, the calibration of straight probe is only one way.

4.7 Adjustment of DAC1 Group

The DAC1 group is for setting the parameters necessary for plotting a DAC curve. It includes **DAC/REVISE**, **RECORD/REVISE POS**, **aSTART/aWIDTH**, **SHOW MARK**, **DAC MODE**

Please refer to 5.4 for making DAC curve.

4.7.1 DAC display control (DAC) / TCG display control (TCG)

This menu is multipurpose for DAC display control and TCG display control. Users can shift the functions for **DAC** and **TCG** by Enter key .

DAC:

It is to turn on/off the DAC display. It will be ineffective when B-scan is on.

Options: ON, OFF

Operation:

- By <Page up> key switch the function page.
- By <F2> key select **DAC1** functional group, and by up and down key, select the functional menu for **DAC**, and then set ON/OFF for DAC Curve by “+” or “-” key.

Note: DAC Display ON/OFF will work only when it has at least 2 DAC record points.

TCG:

It is to turn on/off the TCG display. It will be ineffective when B-scan , AVG、 DAC is on.

Options: ON, OFF

Operation:

- By the <DAC/AVG> key select **DAC1** functional group, and by the <Enter> key, select the functional menu for TCG, and then adjust the TCG by the rotary knob.

Note: TCG curve will display after we have finished DAC curve It will be ineffective when there is no DAC curve .

4.7.2 DAC Plotting Point (RECORD) /DAC Revise Position (REVISE POS)

This menu is multipurpose for DAC plotting point and DAC revise position.

DAC plot is used for recording the echo information necessary for making DAC curve, and DAC revise position is used for positioning the plotting point who needs revising.

RECORD:

Range: 1 ~ 30

Operation:

- Confirm that the gate is working under the state of single gate.
- By <Page up> key switch the function page.
- By <F2> key, select **DAC1** functional group, and by “↑” or “↓” key, select the functional menu for **RECORD**.
- Before each plotting, move gate A to the needed reference echo, and make sure that the reference echo is located within the gate, then add or delete a plotting point by “+” or “-” key.

- Users can shift the functions for **RECORD** and **REVISE POS** by Enter key $\overline{\text{↵}}$.

REVISE POS:

Parameter range: 1 ~ 30, not more than DAC plotting point value

Operation:

- By <Page up> key switch the function page.
- By <F2> key, select **DAC1** functional group, and by “↑” or “↓” key, select the functional menu for **REVISE POS**, and then position the revision point by “+” or “-” key

Users can shift the functions for **RECORD** and **REVISE POS** by Enter key

4.7.3 Starting of the A gate (a START) / DAC Revise (REVISE)

This menu is multipurpose for Start of Gate A and DAC revise , the reason for setting Gate A here again is to make it easy for DAC recording under manual mode; by $\overline{\text{↵}}$, shift the two functions, for details please refer to 4.5.2 for operation.

REVISE:

Re-plot the revision point in 4.7.2. if the curve is not well drawn due to some plotting point with big plotting error, users can select the corresponding plotting point and adjust the gate to corresponding position, re-plot that point by the function of re-plotting.

Option: ON, OFF

Operation:

- By <Page up> key switch the function page.
- By <F2> key you select **DAC1** functional group, and by “↑” or “↓” key, you select the functional menu for **REVISE**, and then revise plotting by “+” or “-” key .

4.7.4 Show Marks/DAC curve mode

This menu is multipurpose for show marks and dac curve mode.by $\overline{\text{↵}}$, shift the two functions.

Show Marks:

We can show DAC marks as X symbol through the function.When one of marks is being revised,it will be show as small pane.

Option: ON, OFF

Operation:

- By <Page up> key switch the function page.
- By <F2> key you select **DAC1** functional group, and by “↑” or “↓” key, you select the functional menu for **Show marks**, and then open it by “+” or “-” key.

Curve mode:

The connection mode between DAC marks.

Option: beelin,curve

Operation:

- By <Page up> key switch the function page.
- By <F2> key you select **DAC1** functional group, and by “↑” or “↓” key, you select the functional menu for **CURVE MODE**, and then select mode by “+” or “-” key .

4.8 Adjustment of DAC2 Group

DAC Group is used for adjusting the relative parameters necessary for plotting a DAC curve. It includes **DAC-EL/ERS-REF**, **DAC-SL**, **DAC-RL**, **CORRECT**.

In order to meet the standard for plotting DAC curve in different industries, the instrument is equipped with three DAC curves with adjustable offsets, which are DAC-EL (evaluating line), DAC-SL (quantifying line), DAC-RL (reject-judging line). In addition, in order that DAC curve can be adaptive to different ambient conditions, Gain Compensation function is provided. The three offset curve are all generated from generatrix, and the generatrix is drawn according to the plotting points and the ultrasonic attenuation. According to their different functions, they appear separately as DAC-RL, DAC-SL and DAC-EL on the screen from top to bottom. CORRECT works for compensating the difference between the surfaces of test block and detected object which will influence the ultrasonic transmission between them. When the CORRECT gets increased, the three DAC offset curve will get lower correspondingly, and contrarily they will get higher.

4.8.1 DAC evaluating line (DAC-RL)/ DAC-REF

This menu is multipurpose for DAC-RL and DAC-REF; by $\overline{\leftarrow}$, shift the two functions.

It is to set the offset of DAC reject-judging line.

Parameter range: -50dB ~ 50dB

Operation procedure:

- By <Page up> key switch the function page.
- By <F3> key select **DAC2** functional group, and by “↑” or “↓” key, select the functional menu for **DAC-EL**, and then set the offset of DAC evaluating line by “←” or “→” key.
- By key $\overline{\leftarrow}$, shift between DAC-EL and DAC-REF

DAC-REF:

DAC-REF means the curve which flaw echo confirm to as standard, “generatrix” or “quantify” is often used, in which generatrix means the primary plotting curve of DAC, another available three standards are all DAC offset. The standard above works only when the DAC is well completed.

Options: GL, RL, SL, EL

Operation procedure:

- By <Page up> key switch the function page.
- By <F2> key select **DAC2** functional group, and by “↑” or “↓” key, select the functional menu for

DAC-REF, and then select the reference curve by “←” or “→” key..

- By key , shift between DAC-EL and DAC-REF.

4.8.2 DAC quantifying line (DAC-SL)

It is to set the offset of DAC quantifying line.

Parameter range: -50dB ~ 50dB

Operation procedure:

- By <Page up> key switch the function page.
- By <F3> key you select DAC2 functional group, and by “↑” or “↓” key, you select the functional menu for DAC-SL, and then set the offset of DAC quantifying line by “+” or “-” key.

4.8.3 DAC evaluating line (DAC-EL)

DAC evaluating line (DAC-EL):

It is to set the offset of DAC evaluating line.

Range: -50dB ~ 50dB

Operation procedure:

- By <Page up> key switch the function page.
- By <F3> key select DAC2 functional group, and by “↑” or “↓” key, select the functional menu for DAC-RL, and then set the offset of DAC reject-judging line by “+” or “-” key.

4.8.4 DAC test standards (STANDARD)

There are 14 standards in DFD20. "Custom ,GB/T 11345-89A ,GB/T 11345-89B,GB/T 11345-89C, JB/T 4730-2005, JG/T 3034.1/2, SY/T 4109-2005, GB/T 3559-94,ASME-3, DL-T 820-2002 A,DL-T 820-2002 B,DL-T 820-2002 C,TB 10212-98D(butt welds) , TB 10212-98J (fillet welds) ". User can set Custom freely, and other standard is fixed.On the option, user press enter key (press the rotary knob) can enter standards set menu,in the menu,we can adjust thickness of workpiece and test block.

Operation procedure:

- By the <F3> key select DAC2 functional group.
- Select the functional menu for STANDARD and then set the dac standards by “+” or “-” key.

4.9 Adjustment of AVG1 Group

AVG1 Group is used for adjusting the relative parameters necessary for a AVG curve. It includes **AVG MODE/CHOCK VEL**, **PROBE NAME**, **FREQUENCY/DIAMETER**, **REF TYPE/REF SIZE**

4.9.1 AVG MODE/CHOCK VEL

This menu is multipurpose for AVG MODE and CHOCK VEL; by , shift the two functions.

AVG MODE:

It is to turn on/off the AVG display. It will be ineffective when B-scan is on.

Options: ON, OFF

Operation:

- By <Page up> key switch the function page.
- By <F4> key select **AVG1** functional group, and by up and down key, select the functional menu for **AVG MODE**, and then set ON/OFF for AVG Curve by “+” or “-” key.

Note: AVG Display ON/OFF will work when it has 1 record points.

CHOCK VEL:

Users are allowed to set the transmission velocity of ultrasonic wave in chock according to the sign on the probe.

Range: 250m/s~16000m/s or 0.0098in/μs~0.6299in/μs

Operation:

- By <Page up> key switch the function page.
- By <F4> key select **AVG1** functional group, and by up and down key, select the functional menu for **AVG MODE**, and then set the transmission velocity of ultrasonic wave in chock by “+” or “-” key.

4.9.2 Probe name

Users are allowed to input the name of the probe, the maxim character number is eight.

Option: ASCII character

Operation:

- By <Page up> key switch the function page.
- By <F4> key select **AVG1** functional group, and by up and down key, select the functional menu for **AVG NAME**, and then set the probe name for AVG Curve by left /right key and Enter key.
- By Enter key  move cursor and by “+” or “-” key to select charater.

4.9.3 FREQUENCY/DIAMETER

This menu is multipurpose for **FREQUENCY** and **DIAMETER**; by $\overline{\leftarrow}$, shift the two functions.

FREQUENCY:

Probe frequency can be input.

Range: 0.5MHz~10MHz

Operation:

- By <Page up> key switch the function page.
- By <F4> key select **AVG1** functional group, and by up and down key, select the functional menu for **FREQUENCY**, and then set Probe frequency by “+” or “-” key.

DIAMETER:

The diameter of probe can be input according to sign.

Range: 3.00mm~35.00mm

Operation:

- By <Page up> key switch the function page.
- By <F4> key select **AVG1** functional group, and by up and down key, select the functional menu for **DIAMETER**, and then set Probe diameter by “+” or “-” key.

4.9.4 REF TYPE/REF SIZE

This menu is multipurpose for **REF TYPE/REF SIZE**; by $\overline{\leftarrow}$, shift the two functions.

REF TYPE:

We must select reflector style on the standard block. There are three reference types in DFD20.

Option:

Flat bottom hole(**FBH**): It is a columnar hole in the bottom and its diameter is equal to the size of the reference flaw.

Short horizontal hole(**SDH**): It is a columnar hole in the side face and its diameter is equal to the size of the reference flaw.

Wide bottom (**BW**): The reflector is equal to infinite flat bottom approximately.

Operation:

- By <Page up> key switch the function page.
- By <F4> key select **AVG1** functional group, and by up and down key, select the functional menu for **REF TYPE**, and then set reference type by “+” or “-” key.

REF SIZE:

The size of reflector in standard block.

Range: 0.50mm~10.00mm

Operation:

- By <Page up> key switch the function page.
- By <F4> key select **AVG1** functional group, and by up and down key, select the functional menu for **REF SIZE**, and then set reference size by “+” or “ - ” key.

4.10 Adjustment of AVG2 Group

The AVG2 group is for plotting a AVG curve and setting the parameters necessary for plotting a AVG curve. It includes **A start/AVG CURVE**、**RECORD REF**、**CORRECT/TEST ATTN**.

4.10.1 Statr of Gate A / AVG Curve

This menu is multipurpose for **Start of Gate A/AVG Curve**; by $\overline{\square}$, shift the two functions.

Statr of Gate A:

Please refer to 4.5.2.

AVG Curve:

AVG Curve is made according to standard reflector, but when the size of standard reflector cannot meet your work, you can adjust its value.

Range: 0.30mm~20.00mm

Operation:

- By <Page up> key switch the function page.
- By <F5> key select **AVG2** functional group, and by up and down key, select the functional menu for **AVG CURVE**, and then set value by “+” or “ - ” key.

4.10.2 RECORD REF

The function is used for plotting AVG curve.

Option: 0 (no record)、1 (recorded)

Operation:

- To make sure that the system is in single gate mode..
- By <Page up> key switch the function pag
- By <F5> key select **AVG2** functional group, and by up and down key, select the functional menu for **RECORD REF**.
- Move gate A to echo we need by “+” or “ - ” key.
- Adjust gain to make echo amplitude equal to 80% of screen.
- Record reference value by right key.
- We can revise the value by deleting it (left key) and recording it again.

4. 10. 3 CORRECT/TEST ATTN

This menu is multipurpose for CORRECT/TEST ATTN; by , shift the two functions.

CORRECT:

The function is used for correcting coupling error between work piece and probe.

Range: -30dB~30dB

Operation:

- By <Page up> key switch the function page.
- By <F1> key select AVG2 functional group, and by up and down key, select the functional menu for CORRECT, and then set correct value by “+” or “-” key.

TEST ATTN:

The function is used for correcting ultrasonic attenuation error in work piece.

Range: 0.0dB~100.0dB

Operation:

- By <Page up> key switch the function page.
- By <F1> key select AVG2 functional group, and by up and down key, select the functional menu for TEST ATTN, and then set correct value by “+” or “-” key.

4.11 Adjustment of Pulse Group

4. 11. 1 ENERGY

ENERGY:

To set the energy of pulse.

Options: 1~5 (from low to high:150v 250v 300v 400v 480v)

Operation:

- By <Page up> key switch the function page.
- By <F1> key select P/R functional group, and by “↑” or “↓” key, select the functional menu for ENERGY, and then set the type of pulse energy by “+” or “-” key.

4. 11. 2 Pulse Width

The function is used for plotting AVG curve.

Option: 30~300 ns

Operation:

- By <Page up> key switch the function page.
- By <F1> key select P/R functional group, and by “↑” or “↓” key, select the functional menu for Pulse Width, and then set the type of pulse energy by “+” or “-” key.

4.12 Adjustment of GAIN Group

The Angle Probe group is used for adjusting and setting the parameters for system gain. It includes **REF GAIN**, **ADD REF**, **SCAN DB**, and **AUTO-80**.

4.12.1 Compensate gain (REF GAIN)

We can set the reference for system gain. It is very useful. When we open the **REF GAIN**, the gain shows as: **XX.X+0.0dB**, the first number is reference of gain, the second number is scan gain. Handlers can set reference before detecting, add or decrease according to the practice in the scene.

Options: ON, OFF

Operation:

- By <Page up> key switch the function page.
- By <F2> key select **GAIN** functional group, and by up and down key, select the functional menu for **REF GAIN**, and then set ON/OFF for **REF GAIN** by “+” or “-” key.

Note: When we close the REF GAIN, only the reference value can be held.

4.12.2 Add reference (ADD REF)

We can add scan gain to reference gain.

Options: ON, OFF

Operation:

- By <Page up> key switch the function page.
- By <F2> key select **GAIN** functional group, and by up and down key, select the functional menu for **ADD GAIN**, and then set ON/OFF for **ADD GAIN** by “+” or “-” key.

Note: When we close the REF GAIN, the ADD REF is of no effect..

4.12.3 Scan gain value (SCAN DB) / Auto set gain (AUTO GAIN)

SCAN DB : We can switch scan gain value between Setting value and 0dB.

Options: ON, OFF

Operation:

- By <Next Page > key switch the function page.
- By <F2> key select **GAIN** functional group, and by **Up/Down** key, select the functional menu for **ADD REF**, and then set ON/OFF for **ADD REF** by “+” or “-” key.

Note: *When we close the REF GAIN, the SCAN DB is of no effect..*

AUTO GAIN : We can use the function to adjust the gain automatically to make amplitude of the largest echo in gate equal X % of the screen

Options: 10%~100%

Operation:

- By <Next Page > key switch the function page.
- By <F2> select **GAIN** functional group, and by **Up/Down** key, select the functional menu for **AUTO GAIN**, and then set X % by “+” or “-” key.

4.12.4 Gain correction (T-KORR)

T-KORR : Set the CORRECT GAIN.

Parameter range: 0dB ~ 60dB step: 0.1dB

Operation:

- By <F2> key select **GAIN** functional group, and by **Up/Down** key, select the functional menu for T-KORR, and then set correct gain by “+” or “-” key..

4.13 Adjustment of B / V Group

B-scan is used for the area difficult to detect and displaying the section plane graph data of this area, the graph shows how the flows locate in the scanning direction in work piece. B-scan can be set beforehand, including **B-SCAN/A-SCAN**, and **SCAN WAY**.

4.13.1 B scan mode select (B-SCAN) / A scan mode select (A-SCAN)

This menu is multipurpose for B scan mode select and A scan mode select.

B-SCAN:

The switch on/off of B-scan mode. When B-scan is turned on, B-scan mode will be displayed on screen. And when DAC/AVG curve is turned on, the switch of B-scan mode will not work. Option: ON,OFF

Operation procedure:

- By <Page up> key switch the function page.
- By <F3> key select **B/V**
- functional group, and by “↑” or “↓” key, select the functional menu for **B/V**, and then adjust option for B-scan by “+” or “-” key.

A-SCAN:

The switch on/off of A0-scan. When the B-scan is on, turn on A-scan, the screen will both of them half and half.

Option: ON,OFF

Operation procedure:

- By <Page up> key switch the function page.
- By <F3> key select B/V functional group, and by “↑” or “↓” key, select the functional menu for A-SCAN, and then adjust option for A-SCAN by “+” or “-” key.

4. 13. 2 Scan way (SCAN WAY)

This menu is multipurpose for SCAN WAY/SCAN MODE; by , shift the two functions.

Scan way determines the refresh way. “left → right” and “right → left” are available.

Option: L->R、 R->L

Operation procedure:

- By <Page up> key switch the function page.
- By <F3> key, select B/V functional group, and by “↑” or “↓” key, select the functional menu for SCAN WAY, and then adjust option for SCAN WAY by “+” or “-” key.

Scan mode determines the refresh mode. → →

Option: ONCE、 CYCLE

Operation procedure:

- By <Page up> key switch the function page.
- By <F3> key, select B/V functional group, and by “↑” or “↓” key, select the functional menu for SCAN MODE, and then adjust option for SCAN MODE by “+” or “-” key.

4. 13. 3 VIDEO/REVIEW

This menu is multipurpose for making video and review.

We can make and play the video of test process on the screen through this function.

Option: On,Off

Operation:

- By <Page up> key switch the function page.
- By <F3> key select B/V functional group, and by up and down key, select the functional menu for VIDEO or REVIEW, and then set review frame value by “+” or “-” key.

Note: 1. When AVG is opened, screen is frozen and making video, the function is no effect.
2. During process of review, we cannot adjust any parameter.

4.14 Adjustment of CFG1 Group

Settings of DETECT/ REJECT, GRID/BRIGHTNESS, BUZZER / UNIT, DATE/TIME are completed in this group.

4. 14. 1 Measuring way (DETECT) /Reject (REJECT)





This functional menu is multipurpose for Measuring way and Reject(REJECT).

DETECT:

To select measuring way.

Option: PEAK, FLANK

Operation:

- By <Page up> key switch the function page.
- By <F4> key select **CFG1** functional group, and by “↑” or “↓” key, select the functional menu for **DETECT**, and then set the measuring way by “+” or “-” key.
- select **CFG** functional group, and by “↑” or “↓” key  , select the functional menu for **DETECT**, and then set the measuring way by key .
- Users can shift the functions for **DETECT** and **REJECT** by Enter key .

REJECT:

This menu is used to reject the echo's display amplitude, for example, to remove the structural noise in the job. It is to reject the display of echo whose amplitude is lower than the setting value by setting a percentage (i.e. percentage at full amplitude).

The suppressing percentage (i.e. percentage at full amplitude) indicates the min. echo height to be displayed. Any echo amplitude lower than this height will be neglected and recorded as zero amplitude.

Parameter range: 0%~80%

Step graduation: 1%

Operation procedure:

- By <Page up> key switch the function page.
- By <F4> key select **CFG1** functional group, and by “↑” or “↓” key, select the functional menu for **REJECT**, and then adjust suppression percentage by “+” or “-” key.

Note: *Please be cautious in using this function, in case that the wave of defect is also suppressed. Additionally, this function is forbidden in some norm for detection.*

4. 14. 2 GRID/ BRIGHTNESS

This menu is multipurpose for Scale and Brightness.

GRID:

It is to set the displaying way of coordinate grid.

Options: 0~3

Operation:

- By <Page up> key switch the function page.
- By <F4> key select **CFG1** functional group, and by “↑” or “↓” key, select the functional menu for **GRID**, and then set the displaying way of coordinate grid by “+” or “-” key.
- User can shift the functions for **BRIGHNESS** and **GRID** by Enter key .

BRIGHTNESS:

It is to set the brightness of the screen.

Options: Max,High,Mid,Low

Operation procedure:

- By <Page up> key switch the function page.
- By <F4> key, select **CFG1** functional group, and by “↑” or “↓” key, select the functional menu for **BRIGHNESS**, and then adjust brightness by “+” or “-” key..
- User can shift the functions for **BRIGHNESS** and **GRID** by Enter key .

4. 14. 3 Sound of the Buzzer (BUZZER)/Selecting the units (UNIT)

This menu is multipurpose for setting buzzer and unit.

BUZZER:

It is used to turn ON/OFF the buzzer.

Options: ON, OFF

Operation:

- By <Page up> key switch the function page.
- By <F4> key select **CFG1** functional group, and by “↑” or “↓” key, select the functional menu for **BUZZER**, and then set ON/OFF the buzzer by “+” or “-” key.

Users can shift the functions for **FILL** and **BUZZER** by Enter key .

UNIT:

It is to select the unit for detection parameters of the instrument.

Options: mm, inch

Operation:

- By <Page up> key switch the function page.
- By <F4> key select **CFG1** functional group, and by “↑” or “↓” key, select the functional menu for **UNIT**, and then set parameter unit by “+” or “-” key.
- Users can shift the function for **LANGUAGE** and **UNIT** by Enter key .

4. 14. 4 Setup Date (DATE)/Setup Time (TIME)

The functional group of Time is for adjusting and setting the real-time clock for the detector. It includes YEAR, MONTH, DAY, HOUR, MINUTE, , when this menu is selected, by  you can shift the six functions, and then adjust parameters by “+” or “ - ” key.

In the function of date, date form is M.D.Y, and in time function, time form is H:M.

Month Setting: setting the month.

Parameter range: 1 ~ 12

Day Setting: setting the day

Parameter range: 1 ~ 31

Year Setting: setting the year

Parameter range: 2000 ~ 2099

Hour Setting: setting the hour

Parameter range: 0 ~ 23

Minute Setting: setting the minutes

Parameter range: 0 ~ 59

4.15 Adjustment of CFG2 Group

Settings of LANGUAGE, Color set, About are completed in this group.

4. 15. 1 Selecting the language (LANGUAGE)

LANGUAGE:

To set the language of displaying.

Options:English, DE,PB

Operation:

- By <Page up> key switch the function page.
- By <F5> key select CFG2 functional group, and by “↑” or “↓” key, select the functional menu for LANGUAGE, and then set the type of language by “+” or “ - ” key.

4. 15. 2 COLOR SET

This menu is for **COLOR SET**;

COLOR: (Only for colorful display)

There are four projects of color for our system.

Option: 0,1,2,3,4

Operation:

- By <Page up> key switch the function page.
- By <F5> key select **CFG2** functional group, and by up and down key, select the functional menu for **COLOR**, and then select color by “+” or “-” key.
-

4. 15. 3 PC MODE

This menu is for PC MODE;

PC MODE:

The instrument is equipped with USB interface, can achieve communication with PC at up level. Connect the instrument with PC USB interface, and enter into PC mode for the instrument to communicate with PC.

Option: Open、Close

Operation:

- By the <System Config> key select **CFG2** functional group, select the functional menu for **PC MODE** and then open the pc mode by the rotary knob .

4. 15. 4 About

This menu is for **ABOUT**;

ABOUT:

Information of manufacture.

Option: Open、Close

Operation:

- By <Page up> key switch the function page.
- By <F5> key select **CFG2** functional group, and by up and down key, select the functional menu for **ABOUT**, and then see information of manufacture by “+” or “-” key.
- By <F5> key exit.

4.16 AWS Group

The AWS menu provides a means for evaluation discontinuities when inspecting welds in accordance

with the American Welding Society’s Structure Welding Code, ASNI/AWS D1.1-94. The user is referred to the AWS standard for all details of the method.

The AWS menu provides a convenient method of automatically calculating the Indication Rotating (IR) as defined by the standard. The AWS menu can be used in conjunction with the trigonometry mode which will simultaneously indicate beam path, surface distance and depth distance at the bottom of the graticule.

$$D \text{ Rating} = A \text{ INDI} - B \text{ REF} - C \text{ ATTEN}$$

D Rating = Is the difference in dB between the indication and the reference gain with attenuation factor correction

A INDI = is the dB setting required to bring an indication to the reference level

B REF = is the dB setting of the calibrated reference indication as a function of the reference standard and probe being employed.

C ATTEN = is the attenuation factor required by the AWS standard.

$$C = 0.079 \text{ dB/mm} (s - 25.4 \text{ mm})$$

s = sound path of flaw echo. C ATTEN is automatically calculated

by unit. When the S ≤ 25.4mm C ATTEN is 0.

For example

1. Record defect amplitude is 40 dB (A)
2. Record reference echo amplitude (B) 36 dB and distance (C) 3 inch
3. 40-36-4=0

Note: AWS only work with AWS size and Frequency Probes.

To set the AWS measurements, perform the following

INDICA> 77.0dB	aSTART> 70.00mm
REFRNCE 71.5dB	
ATTEN 3.5dB	
RATING 2.0dB	

1. Calibrate the probe
2. Set Velocity.
3. Set right display range
4. Put the probe on test block reference hole, For example IIW Type I, 1.5 mm dia. Hole. Adjust the gain until back echo raise to 80% full screen
5. Press “ Gate”, move aGate across the echo, adjust the gate length, high
6. Press “ FN” key move the high-light cursor to “AWS” position. Select AWS REFRNCE dB, press “+” key to get

REFRNCE dB.

Now the instrument will automatically adjust the gain, The echo in the aGate will automatically raise or decrease to 50% full screen.

7. After complete AWS setting, It can start inspection
8. Move the probe detected the flaw.

9. Move aGate cross flaw echo.
10. Select AWS INDICA dB, press “+” key to get INDICA dB.
Now the instrument will automatically adjust the gain, The echo in the aGate will automatically raise or decrease to 50% full screen.
11. Now the instrument will automatically calculate the ATTEN and RATING.

4.17 Adjusting of Special Functions

In order to make it easy for the user to use, on the instrument’s panel, in addition to the selection for menu-type functional groups, there are also 7 keys of Special Functions that are used frequently, including Adjust of Gain Step, Gain+/-, Print Report, Full-screen Display, Waveform Freeze and extend, etc.

4.17.1 Gain Step

It is to adjust the length of gain step.

Options: 0dB, 0.1dB, 0.5dB, 1.0dB, 2.0dB, 6.0dB and 12.0dB

Operation procedure:

- By pressing Gain Step , the gain’s step graduation will change cyclically in the option.

4.17.2 Gain

When the gain step is adjusted to proper option, you can set the gain by Gain +/- .

Parameter range: 0dB~120dB

Operation procedure:

- By pressing key +/- , the gain will change in the gain step set at present.

4.17.3 Full-screen

It is used to switch between full-screen display and normal display for waveform.

Operation:

- Users can switch over full-screen and normal display modes by pressing full-screen key .

Note: 1. Under full-screen state, only Special Functions of the instrument are effective, and all other functions will not work.

2. Full-screen can not work when the detecting displaying is dB or under B-scan mode.

4. 17. 4 Freeze

It is used to freeze the waveform.

Operation procedure:

- The gauge can be switched between freezing and non-freezing by the Freeze key .
- Under Freeze state, prompting icon * appears in the status line.

Note: *Under Freeze state, both the functions for Gate Group and MEM Group of the instrument are effective, DAC On/Off can switch over. The functions of other functional groups will not work.*

4. 17. 5 Peaks Memory

Peaks Memory is used for users to conveniently find out the flaw peak and estimate the flaw accurately.

Operation:

- By pressing <  > key, we can open and close the function .

Under peaks memory state, prompting icon 'P' appears in the status line.

4.17.6

4. 17. 6 Test Data Display

We can select display method of measure result on the top right corner of display area. One of S-path, Projection and Depth will be displayed here and the other two will appear in the status bar. When dB is displayed , values S-path data got from DAC curve will appear on the screen. If DAC curve is turned off or the waveform in gate is over the screen, dB will appear as “*”.

Options: S-PATH, P-VAL, DEPTH, VAL-SZ, VAL-mm

Operation:

- Press “Measure Display ” key to select display method of measure result.

4. 17. 7 Save key

It is used to save results of the test for details by key 



Operation:

- Press the key to save results of the test.

4. 17. 8 Shortcut functional key

Detection zone、 gate A、 Auto gain is the functions in common use, so we set shortcut functional key for them.



Operation:

- Press “” key to switch to detection zone menu quickly for adjustment of detection zone.
- Press “” key to switch to gate A menu quickly. Press this key continually to select Gate A start, Gate A width or Gate A height for adjustment of corresponding functions.
- Press “” key to adjust the gain automatically to make amplitude of the largest echo in gate equal X% of the screen.
(x%:10%~100%)

4. 17. 9 Resetting the Ex-factory Setting

Users can recover the ex-factory parameter setting when turning on the machine if necessary.

Operation:

- When it displays the progress bar for Turn on screen by pressing down  and , you can recover the ex-factory setting.



Note: 1. Only one of the recovered ex-factory setting and recovered setting at last turning off is valid at the same time.

2. The settings in all the settings will not be canceled if resetting the Ex-Setting.

4. 17. 10 Instrument program upgrade

DFD20 provides online upgrade function, and operator can perform program upgrade process by tools DataView for DFD20 after getting necessary upgrade files.

Operation:

- Connect interface of the instrument and PC by the special-purpose communication cable (Reference the chapter V).
- If the instrument cannot set up normally, operator can press the keys of  and  when it displays the progress bar for Turn on screen. Thus, the instrument will keep the turn on screen but not shift to the operation interface.

Finish program upgrade according to 《DFD20 Ultrasonic Detector Operation Instructions for PC Data Processing

Software»

Chapter V Calibrating the Instrument and Measuring

Before working, it is necessary to calibrate the sound speed, pitch interval and probe delay for the instrument, so as to be adaptive to the detection condition. Where, the reason for calibrating sound speed and probe delay is that the calculation of parameters displayed in the status line is relative with sound speed and probe delay, therefore you must calibrate before detection; while the purpose for calibrating pitch interval is to make it display waveform in proper range of pitch interval on the screen, so as to judge and evaluate the defects better.

In order to operate the instrument safely and correctly, the calibrated shall be calibrated by a professional technician from field of ultrasonic detection.

In order to illustrate well the calibrating way and steps, examples will be given later.

5.1 Calibrating of Single Probe

You should determine the calibrating procedures depending on the known condition of sound speed and probe delay. If the sound speed is unknown, you first calibrate the sound speed by way of “Two Points”; if the sound speed is known, calibrate the probe delay by one-point way after adjusting the sound speed into the known one.

5.1.1 Calibrating with Known MTLVEL

Procedure:

- The MTLVEL setting is the known sound speed of the material,
- Couple the probe with the calibrating test block,
- Set the Gate Logic into Single-Gate mode, i.e. Positive or Negative logic, loop the gate on the primary echo,

now the pitch interval measured is the pitch interval at primary echo,

- Adjust the probe delay, so that the measurement of pitch interval in the status line is the same with the known thickness of the test block.

Note: For an angle probe, before calibration, you have to enter thickness T of the test block and probe's front edge X, the rest calibrating steps are the same.

5.1.2 Calibrating with Unknown MTLVEL

Procedure:

- First set a rough sound speed value;
- Adjust the gate logic into Double Gate mode;
- Couple the probe with a test block for which the thickness is known and that is of the same material with the job;
- Move the start of gate A to the primary echo and make them intersect, adjust the height of gate A to be lower than the max. amplitude of primary echo and to a proper position, and gate A shall not intersect with the secondary echo;
- Move the start of gate B to the secondary echo and make them intersect, adjust the height of gate B to be lower than the max. amplitude of secondary echo and to a proper position, and gate B shall not intersect with the primary echo;
- Then adjust the sound velocity, so that the pitch interval displayed in the status line is same with the actual thickness of the test block. The sound velocity got now is the actual sound velocity under this detection condition;
- Set the Gate Logic into Single-Gate mode, i.e. Positive or Negative logic, the pitch interval measured at this time is the pitch interval at primary echo;
- Adjust the probe delay, so that the measurement of pitch interval in the status line is the same with the known thickness of the test block. The probe delay measured at this time is the exact P delay of this probe.

In the following we'd like to illustrate by an example:

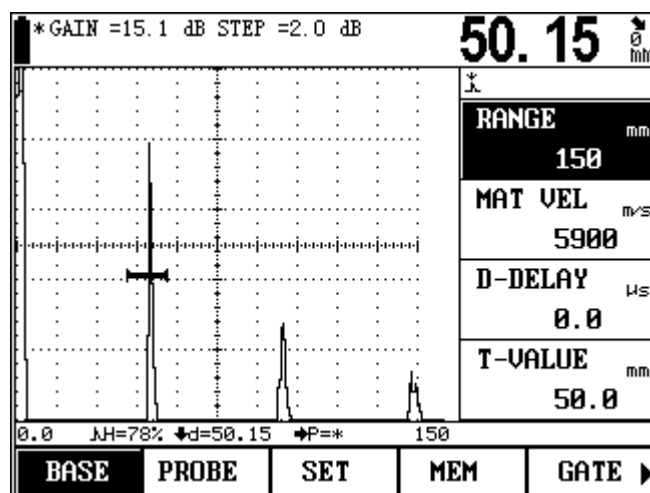

Fig.5.1 Calibrating with unKnown MTLVEL

MTLVEL is unknown, set the approximate MTLVEL as 5920m/s, set the Gate Logic as double gate mode, meanwhile set the P delay as 0;

Couple the probe with a calibrating test block of 50 mm, and adjust the gate A to a position intersecting with the primary echo, Adjust gate B to a position intersecting with secondary echo;

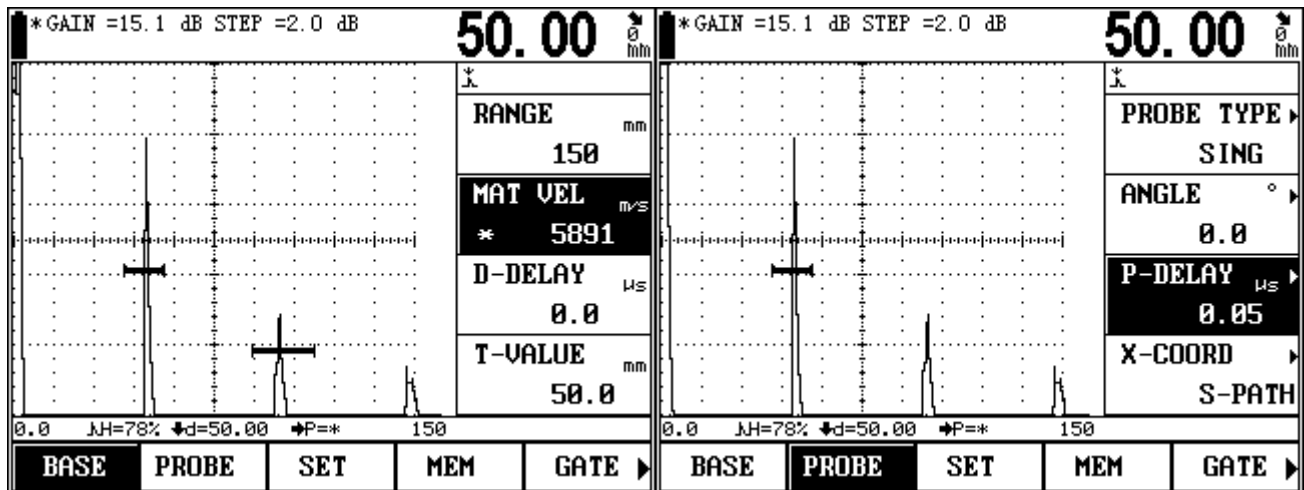

Fig.5.2 Calibrating MTLVEL

Fig.5.3 Calibrating P-DELAY

Increase MTLVEL, till the displayed pitch interval between the primary and secondary echo is 50mm, now we get the exact sound velocity of the material, i.e. 5891m/s; Set again the gate as Single Gate mode, measure the pitch interval at the primary echo, adjust continuously P Delay till the pitch interval measured at the primary echo is 50 mm, now we get the exact P Delay, i.e. 0.05us.

5.2 Calibrating of Double Probe

Calibrating procedure:

- Set double-probe state in PROBE group;
- Set the pitch interval, functional items in PROBE group depending on current testing task and probes selected;
- Couple the probes with the calibrating test block, adjust the P Delay in Base group till the calibrating echo approaches to the desired position, meanwhile the secondary echo is also within the display range;
- Adjust the gain till the echo with the max. amplitude approaches to the full-screen height;
- Turn on double gates in Gate group;
- Select Front-edge measuring way in CFG group;
- Move the start of Gate A to the primary echo and intersects with it, and Gate A shall not intersect with the secondary echo;
- Move the start of Gate B to the secondary echo and intersects with it, and Gate B shall not intersect with the primary echo;
- Adjust gate heights, so that they are at the same positions of the front edges of two standard echoes;
- Change the sound velocity, till it displays the thickness value of the standard test block;
- Set the Gate Logic into Single-Gate mode, i.e. Positive or Negative logic, the pitch interval measured at this

time is the pitch interval at primary echo;

Adjust the probe delay, so that the measurement of pitch interval in the status line is the same with the known thickness of the test block.

5.3 Calibrating of Angle Beam Probe

calibrating of angle beam probe is usually as following: 1. calibration of incidence angle (X-Value); 2. calibration of probe angle (K-Value); 3. calibration of material sound speed; 4. calibration of probe Zero point.

1. Calibration of incidence angle (X-Value): Test the probe zero point with Π W test block (Holland test block) or

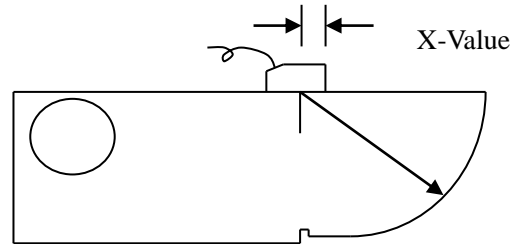

CSK- I A test block, firstly adjust the sound speed to

3230m/s, detecting range to 150mm, then start the testing, locate the probe on test block and move it as the right figure to make sure you have got the highest echo on R100mm reflector, measure the distance, which is the X-Value of probe, between the front face of probe and cycle center of R100m arc. The point corresponding to the cycle center of R100mm arc is just the incidence point of probe.

2. Calibration of probe angle (K-Value): the probe plotted

with angle value can be calibrated with Π W test block, and the probe plotted with K-Value can be calibrated with CSK- I A test block. Both the two kinds of test blocks have the scales of angle and K-Value, select the proper scale for the probe(as shown on the right figure,

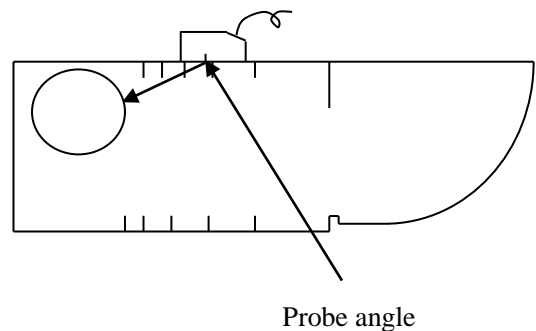

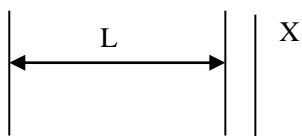

on the upside of Π W test block probe of 60~76 degrees can be calibrated, the downside is suitable for the probe of 74~80 degrees. And on the upside of CSK- I A test block probe of K2.0, K2.5, K3.0 can be calibrated, the downside is suitable for probe of K1.0, K1.5). locate the probe as the right figure shows, move the probe back and forth to make sure you have got the highest echo, and now the scale corresponding with incidence point is the probe angle or K-Value.

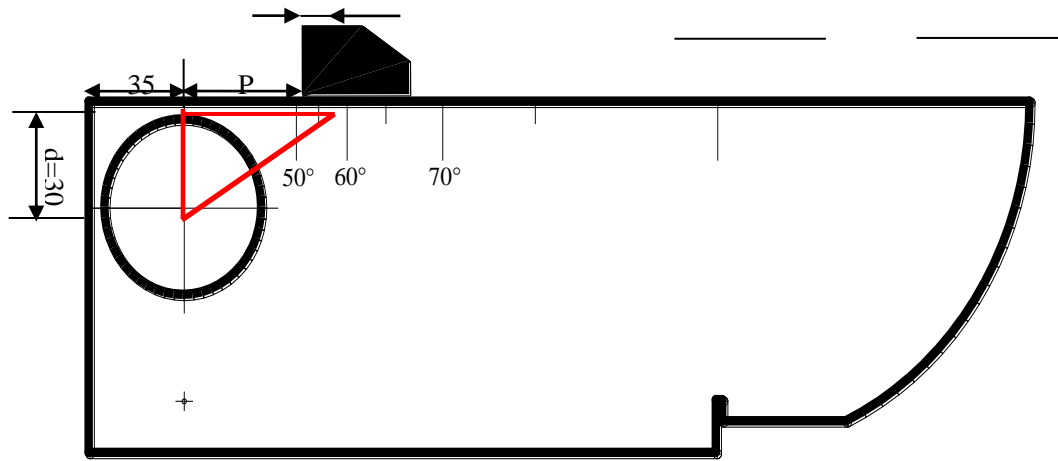

$$K = \frac{P+X}{d} = \frac{(L-35) + X}{30}$$



When the focus on angle menu, press  key , we can input L value (above picture),and then press  key again,the unit will calculate the angle value.

3. Calibration of sound speed: find out the highest echo in item 1, and adjust the detecting range to make sure the second echo of this echo can be displayed on the screen, switch the gate mode to double gate, adjust the A gate to cut with the first echo, and adjust B gate to cut with the second echo, adjust the sound speed to make the value of sound path(S) be 100, now the sound speed value you get is the actual sound speed.
4. calibration of probe zero point. Keep the testing status above, and change the gate mode to plus or minus, adjust the probe zero point to make the value of sound path (s) return to 100, now the zero point value is the actual zero point value.

Angle beam probe can be calibrated in many ways, not only by standard test blocks, it can also be done with a thickness known hole, theoretically, smaller of the reference reflector more accurate calibration you will get, however, it will be more difficult to do so. When calibrating with holes, we can do the calibration on angle by working out slope through measuring the depth and level position of hole, and with which processing the calibration of sound speed and probe zero point.

5.4 Application of DAC Curve

DAC curve is used for distinguishing the reflectors with the same size and different distance. Normally, in work piece, reflectors with the same size and different distance cause change in amplitude because of the attenuation of material and pervasion of beam. The DAC curve compensate for attenuation of material, magnetic field influence, pervasion of beam and surface smoothness in the way of graph. Normally, the echo peak points are all located in the same DAC curve. And in the same way, the echo created by smaller reflectors will be located under this DAC curve, and the bigger one will be above the curve.

1. **Selection of detecting setting.** Select the advanced function group by Page key and function key <F4>, adjust the detecting setting number, choose one as the current instrument setting setting, for example, No.1, (Note: One group of DAC plotting points can be saved in one setting, and they are saved automatically, not needing any operation, if you want to save the parameter setting at the same time, turn to the operation “ADV”

“SAVE”.

2. **Turning on DAC curve function.** Select the DAC1 function group through Page key and function key <F2>, and then select the DAC curve function through S1 and up/down keys, (if the DAC curve function doesn't lie in the current menu, please switch it by the key  or S1, plot the revision function), set the DAC curve switch by “←” or “→” key.
3. **Making DAC curve.** Select the DAC1 function group through Page key and function key <F2>, Add plotting points according to 4.7.2, when two plotting points are finished, the DAC curve will be protracted automatically. (Note: Plot the points in the order of small to large according to the detecting range, and the echo height of latter one must not be higher than the fore one, other wise, the DAC curve will be a beeline.)
4. **Adjust the offset of the three offset curves.** Select the DAC2 function group through Page key and function key <F3>, adjust the three offset curves viz. DAC-EL, DAC-SL and DAC-RL to proper settings.
5. **Compensation for surface roughness.** Select the DAC2 function group through Page key and function key <F3>, adjust the gain correct menu to compensate for the surface roughness of work piece, for example, when 5dB is needed, just adjust the gain correct to -5dB, and now the three DAC curves will go down for 5dB.
6. The completed DAC curve:

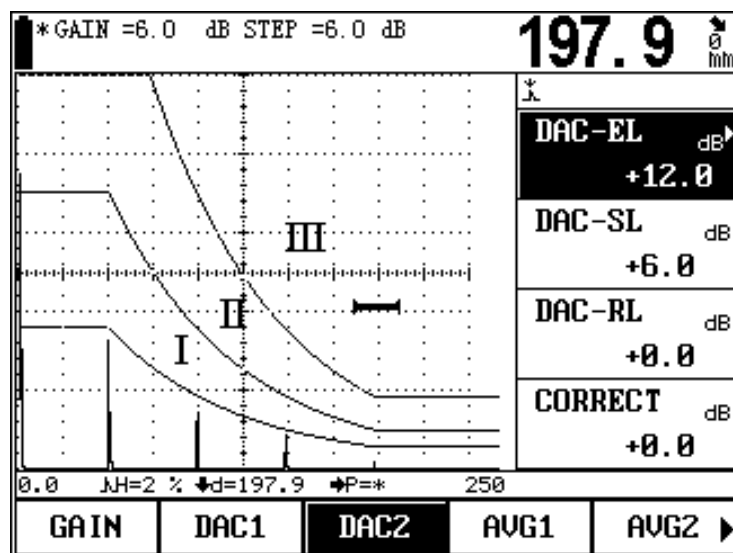

Fig. 5.4 DAC curve

The screen is divided into three areas, I, II and III. The three curves will be drawn on the screen during the detecting, users can determine the flaw character by the height of the echoes.

5.5 Contents of Measurement

To use the detector for measuring, you shall carry out the following works:

Set the start of gate, gate width, gate threshold and gate alarming way.

Contents of measurement are:

S Pitch interval

H(%) Relative value of echo height in gate range (relative to the screen height)

- h Absolute value (in pixel) of echo height in gate range
 d Depth of defect
 D(%) Relative value of defect depth (relative to job's thickness)
 P Horizontal distance of the defect from the probe's front edge

As for the meanings of above parameters, please refer to the following figure.

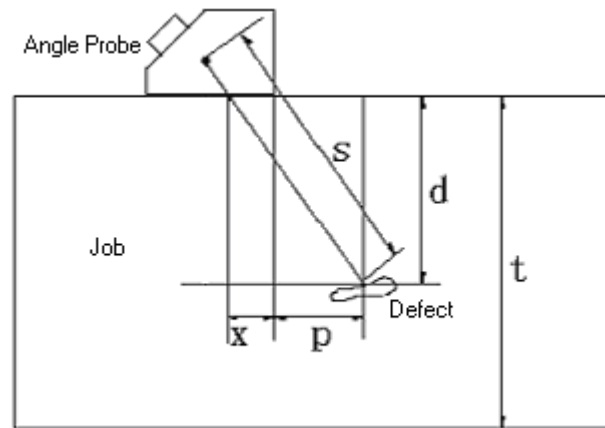

Where:

- s: Pitch interval;
 d: Depth of defect;
 t: Thickness of job;
 x: Distance of ultrasonic source to the probe's front edge;
 p: Horizontal distance of the defect from the probe's front edge;
 D: Is the relative value of defect depth, it is obtained by the following formula:

$$D = \frac{d}{t}$$

Matters needing attention before measuring:

The calibration including sound speed and P delay shall be completed, and the measuring way can be selected as front-edge and peak way. The wave amplitude measured is the max. echo amplitude within the gate. With front-edge measuring way, the pitch interval measured is the pitch interval at front edge of echo within gate (up line of echo waveform curve). Therefore, when front-edge way is selected, the measurement on echo amplitude in the gate is influenced by the gate threshold (height).

The measurement of pitch interval can be done only when the gate is open, before measuring, you should select the measuring way: edge way and peak way. Then select single or double gate way. Under single-gate way, the measurement is the pitch interval at echo's front edge or peak in the gate. Under double-gate way, the measurement is the pitch interval starting from the echo within gate A and ending at the echo in the gate B.

Chapter VI Communication for the Instrument

The instrument is equipped with USB interface, can achieve communication with PC at up level. Connect the instrument with PC USB interface, and enter into the special operation software Data View for the instrument at PC.

6.1 Data Communication

In the instrument, the baud rate of RS232 serial port is fixed 9600, one start bit, two stop bits, 8 digital bits, and there is no check bit.

6.1.1 Connecting PC

USB connecting way One end of the standard USB cable connects with USB interface of the instrument, another end with USB port of PC. The instrument will upload the images and data saved through USB port to PC. The customer software installed on PC can edit, save or print the images and data.

-
- Note: 1. Before connecting or disconnecting USB with/from the instrument or PC, please first turn off the instrument.*
- 2. During the communication, never remove the communication cable, turn off PC software just as you like, otherwise the communication will fail hence the instrument will not work.*
- 3. If any abnormality happens which results in failure in communication, please re-start the instrument.*
-

Chapter VII Maintenance and Repairing

7.1 Requirement on Environment

Avoid seriously bumping, heavy dust, damp, strong magnetic field and greasy dirt, etc.

It is strictly forbidden to wipe the casing with any solvent substance.

7.2 Charging the Battery

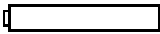
The status sign for battery on ELD reflects in real time the condition of battery voltage. When the battery voltage is to low, i.e. when the status sign for battery on ELD becomes the sign of under  voltage in the following, you have to charge the instrument as soon as possible.

The charging way is as follows (you can charge either with the instrument on or off):

- a. Insert the power plug of the power adaptor into the charging socket;
- b. Connect the power adaptor with 220V/50Hz local power supply, both the Charging indicator lamp (red) and rapid charging indicator lamp (green) light up;
- c. When the rapid charging indicator lamp (green) goes out, the battery is fully charged. In a normal case, you can charge full the battery in about 4.5h.
- d. Pull off the charging plug, the charging ends.

-
- Tip**
1. *The input voltage of the power adaptor is 220V, its output is 9V DC, the max. current is about 1000mA, the max. charging time is about 6h.*
 2. *This instrument uses Li ion battery, therefore when sign of under voltage appears, you have to charge timely, and over discharge will damage the battery.*
 3. *If the instrument will not be used for a long time, it must be charged once a month to avoid over-discharging and damage the battery.*
 4. *If the battery can not work any more for over discharging(battery with no power and the charging indicator don't work), pull out the charger and wait for about two minutes then plug it again, repeat it several times, the battery will refresh on top of that.*
 5. *The instrument can work while charging.*
-

7.3 Troubleshooting

If the following failures occur,

- a. The Instrument can't turn off automatically;
- b. Can't measure;

- c. The keys don't work;
- d. The measurements change frequently,

the user shall not open the instrument and repair it by himself. After filling the Warranty Card, please send the instrument to the Maintenance Dep. of our company for executing the warranty regulations.

If you can brief the failure and send us the description, we'll be very gratified.

7.4 Tips on Safety

The design of the instrument meets relative safety standard. During the operation, it shall meet the specified external ambient condition, and the operator shall be furnished with concerned technology background, so as to guarantee safe operation. Before putting the instrument into operation, please read carefully the following tips on safety:

-
- Note: 1. This instrument is a non-destructive inspection instrument for inspecting material, it is not allowed to use as a medical instrument.*
- 2. The instrument is limited to be used in lab and industrial environment.*
-

System Power Supply

The instrument can be supplied power either with external power adaptor or Li ion battery. When selecting power adaptor and battery, please use the products recommended by us.

For charging and replacing battery, please follow our operation procedures.

System Software

Any software may have error, but we have done our best to minimize the probability for this kind of error. The software of this instrument has passed overall and strict test.

Unexpected Fault

When the following abnormal situation happens, it means there is fault in the instrument, please turn off it and take out the battery if necessary. And send the instrument to a specified service point for repairing.

- a. The instrument has suffered obvious mechanical damage (e.g. serious extrusion or collision during transportation);
- b. The instrument keyboard or screen display is abnormal;
- c. It is stored in an environment with high temperature, high humidity or that is corrosive;

Appendix

Appendix I Notice to User

I. After purchasing product from our company, please fill carefully the *Warranty Registration Card* and seal your official stamp on it. Please send copy (I) and the copy of invoice to the User Service Dep. of our company, or you can ask the seller to send that on your behalf. The copy (II) will be sent to (left at) the maintenance station of local branch for going through registration formalities. For any area without maintenance station, please send copy (I) and (II) back to the User Service Dep. of our company. When the formalities are not complete, we can only maintain but offer no warranty service.

II. For any product from our company, since the date the user purchases it, if it has any fault in term of quality (except for non-warranty parts), please contact the maintenance stations of local branches at different areas of our company for repairing, replacing or returning by using the “Warranty Card” (the copy kept by the user himself) or the copy of the invoice issued when purchasing the product. During the warranty period, if one has no way to show the warranty card or the copy of the invoice, we will count the warranty period based on the shipping date, and the period is one year.

III. If any product of our company has fault after the warranty period, the maintenance stations at different areas will be responsible for the after-sale service, maintaining the product and charging the maintenance cost according to prescription of our company.









IV. The “special configuration” (shaped probe, special-purpose software, etc.) beyond our established product will be charged according to concerned criteria.





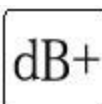
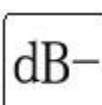

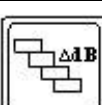
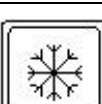
V. Our company will not warranty any product which is damaged because the user has disassembled by himself, due to improper transportation and storage or incorrect operation not following the “Operation Instructions”, as well as for which one has altered the Warranty Card and one has no Purchasing Proof, etc.

Appendix II List of Operations

All operations of DFD20 are realized by direct triggering of different key(s) on the panel or combination of them.

The following list shows the concrete icons, names and functions of panel keys.

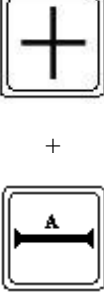
Figure	Name	Function
	Fn	Press Fn key to select corresponding function group listed at the bottom, and all function items in this group will display at the right.
	Direction	Press the key to select items in the function group.
	Adjust parameters	Press them to increase or decrease value of the parameters or select different selections ,but Gain value should be adjusted by using dB+ and dB- specially.
	Confirm	Press “Confirm” key for switch of multi-used function item. Primary or fine adjustment of function items (if available) can be selected via “Confirm” key.
	Gain +	Press Gain + key to increase the gain by set step. Gain adjustment range is 0dB~110dB.
	Gain -	Press Gain - key to decrease the gain by set step. Gain adjustment range is 0dB~110dB.
	Freezing	During operation, press “Freezing” key to freeze the wave and data displayed on the screen. Press again for defreezing.
	Gain step	Press “Gain Step” key, the gain step will display 12.0dB, 6.0dB, 2.0dB, 1.0dB, 0.5dB, 0.2dB and 0dB in cycle. Select suitable gain step for fast adjustment of gain.
	Freezing	During operation, press “Freezing” key to freeze the wave and data displayed on the screen. Press again for defreezing.
	PageUp/PageDown	All function groups are arranged in different pages, press “PageUp/PageDown” key to go to expected page.

	Full Screen	In ASCAN mode, press “Full Screen” key to select normal mode and amplified mode of display.
	Peak Memory	Press “Peak Memory” key to enable/disenable peak memory.
	Save	Press the key to save results of the test.
	Measure Display	Press “Measure Display” key to select display method of measure result.
	Soft power switch	Start/shutdown the machine.
	Combined Key 1	<ol style="list-style-type: none"> 1. Press “Combined Key 1” as startup and loading of the program to restore ex-factory configuration. 2. To avoid accident change to current flaw detection parameters in the operation window, press “Combined Key 1” to lock the menu. Press “Combined Key 1” again to unlock.
	Combined Key 2	<ol style="list-style-type: none"> 1. Press “Combined Key 2” as startup and loading of the program to enter communication status. 2. To avoid accident deletion of stored flaw detection curve in the operation window, press “Combined Key 2” to lock the curve. Press “Combined Key 2” again to unlock. 3. To avoid accident deletion of configuration of current setting in the operation window, press “Combined Key 2” to lock the setting. Press “Combined Key 2” again to unlock.
R	Charge LED	This LED (Green) illuminates during charging and goes off as charge ends.
A	Alarm LED	This LED (Red) illuminates to alarm .

Appendix III 6dB DAC CURVE SETTING STEPS

1. Open DAC. Set the DAC MODE to Line.

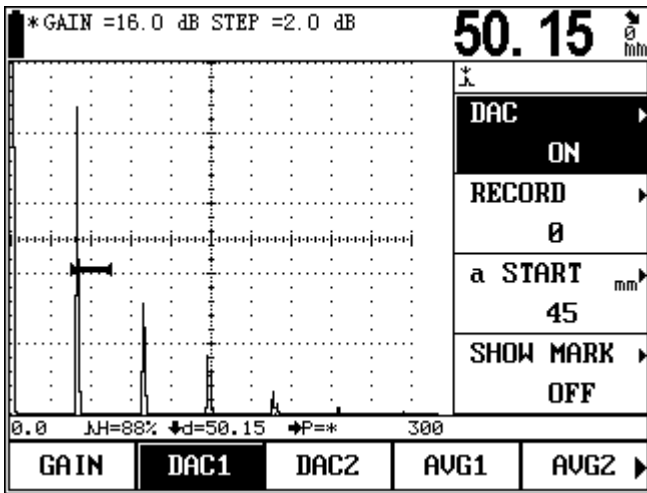

2. Record the first point.

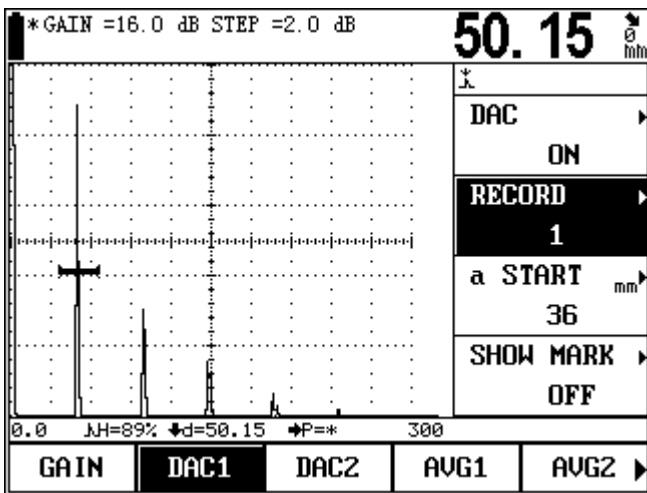

3. Record the second point.

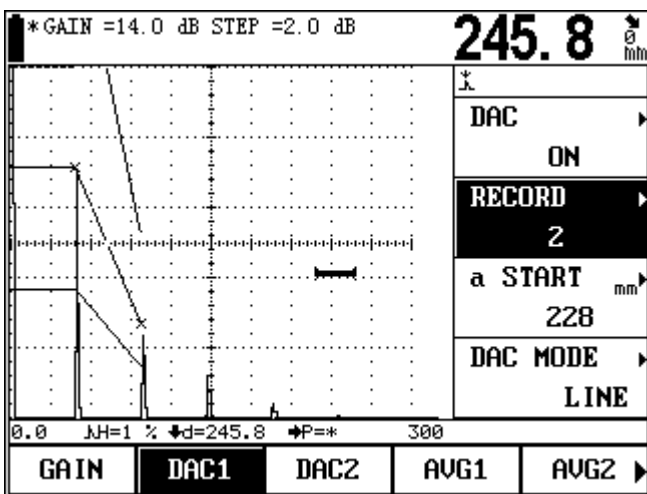

4. Record the third point.

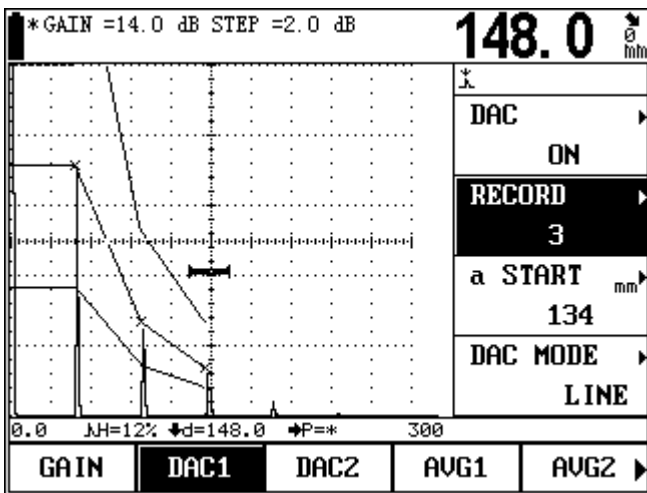

5. Press  to enter 6dB DAC. Two conditions:

- 1) Focus on RECORD;
- 2) The count of DAC points ≥ 3

'A' mark will appear. And the echo will be doubled (6dB) from the third point. (The start point must ≥ 3)

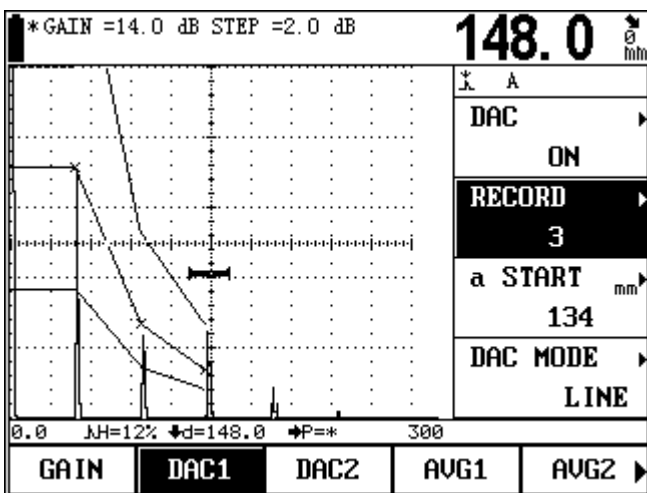

6. Record the fourth point.

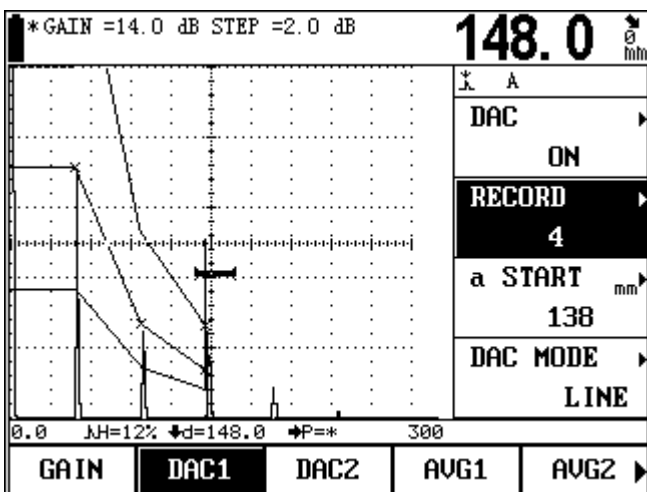

7. Record the fifth point.

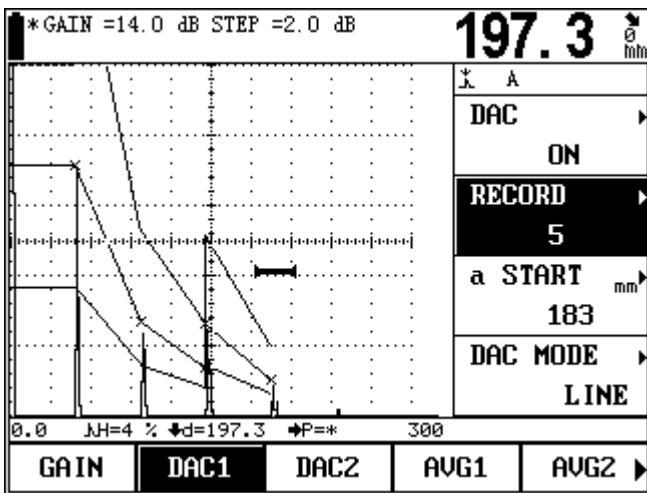

8. Record the sixth point.

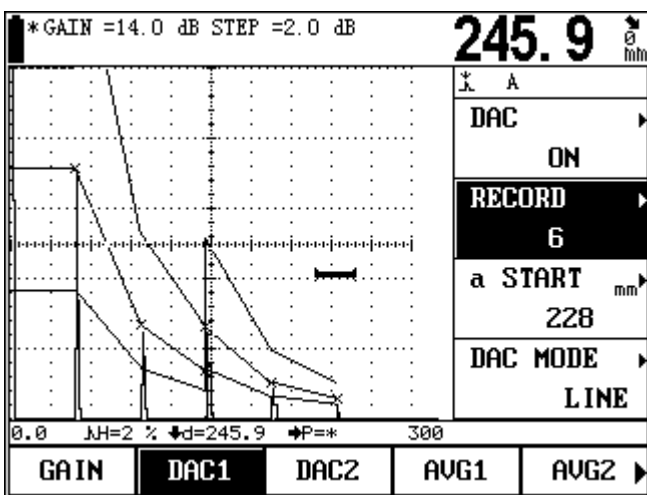

9.If we want to exit 6dB DAC mode, we must delete the points behind the start point(the third point),then Press

 to inter 6dB DAC.when the focus is on 'RECORD';

Appendix IV Terms

This Appendix has listed the terms concerning ultrasonic non-destructive inspection involved in the Instructions, a good understanding of the exact meaning of these terms will be helpful for using the Instructions better.

1. Pulse amplitude: voltage amplitude of a pulse signal. When type A display is used, normally it is the height from time base to the pulse peak.
2. Pulse length: duration of a pulse in term of time or no. of cycles.
3. dB: the logarithmic expression of the ratio of two amplitudes or strengths.
4. Sound impedance: ratio of sound voltage of acoustic wave to a particle's vibration speed, normally it is expressed by the product of density p times by velocity c of the media.
5. Matching of sound impedance: coupling of two media equivalent to the sound impedance.
6. Attenuation: the phenomenon that the sound voltage weakens gradually when an ultrasonic wave propagates in the media as the propagation distance increases.

7. Total attenuation: the weakening in sound voltage in special waveform for ultrasonic beams of any shape that is caused jointly by scattering, absorbing and diffuse of acoustic beam, etc. as the propagation distance increases.
8. Attenuation coefficient: loss of sound voltage in unit distance due to material scattering when the ultrasonic wave is propagating in media, normally it is expressed by dB/cm.
9. Defect: discontinuity whose size, shape, direction, position or nature will damage the effective use of a work piece, or that doesn't meet the specified acceptance standard.
10. Type A display: a kind of way for expressing information where horizontal base (X axis) is used for expressing distance or time, and the deflection which is vertical to the base (Y axis) is used to express the amplitude.
11. Sending pulse: electric pulse added to the energy exchanger for producing ultrasonic wave.
12. Time-base line: horizontal scan line expressing time or distance in type A display fluorescent screen.
13. Scan: the repeated movement of the same style from electronic beams that runs cross the detector's fluorescent screen.
14. Scan range: Max. pitch interval that can be displayed on the time base line of the fluorescent screen.
15. Scan speed: ratio of cross axis to corresponding pitch interval on the fluorescent screen.
16. Delayed scan: a kind of scanning way where the starting part of the time base will not show in type A or B display.
17. Horizontal linearity: the extent for the signal displayed on the time or distance axis of the ultrasonic detector's fluorescent screen to be proportional to the signal entered into the receiver (multiple echoes from the calibrated time generator or from a plate whose thickness is known).
18. Vertical linearity: the extent for the signal displayed on the time or distance axis of the ultrasonic detector's fluorescent screen to be proportional to the amplitude of signal entered into the receiver.
19. Dynamic range: with constant gain adjustment, ratio of wave height of the max. to the min. reflection area that can be identified on the ultrasonic detector fluorescent screen. It is normally expressed by dB.
20. Repeating frequency of pulse: no. of pulses the pulse generator uses for exciting the probe's wafer per second to generate the ultrasonic wave.
21. Inspection frequency: frequency of ultrasonic wave used during ultrasonic inspection. Normally it is 0.4 MHz ~15MHz.
22. Frequency of echo: inverse of time of peak interval obtained by observing when the echo extends on the time axis.
23. Sensitivity: a kind of dimension for the min. ultrasonic signal identifiable that is generated on the ultrasonic detector's fluorescent screen.
24. Allowance of sensitivity: difference between the standard and max. defect-detecting sensitivity in term of certain electric level in an ultrasonic detection system.
25. Resolution: capability of an ultrasonic detecting system for extinguishing two adjacent defects of certain size that are most close to each other in transverse, longitudinal or depth direction.
26. Suppress: a kind of controlling way to reduce or remove signal of low amplitude (electric noise or noise from material) so as to highlight the high signal in an ultrasonic detector.
27. Gate: An electronic method for selecting a time range for monitoring the detecting signal or for further processing.
28. Attenuator: a unit changing quantitatively the signal voltage (sound voltage).The attenuated volume is expressed

by dB.

29. S/N ratio: ratio of ultrasonic signal's amplitude to the max. background noise's amplitude. It is normally expressed by dB.
30. Blockage: a phenomenon occurred in the moment after the receiver receives the sending pulse or strong pulse signal where its sensitivity drops or it fails.
31. Gain: the log form of voltage amplification of the receiving amplifier of the ultrasonic detector. It is expressed by dB.
32. Distance-amplitude curve (DAC): a set of curve plotted according to specified condition by three parameters, i.e. distance of the known reflector, gain of the detector and size of the reflector that generates echo. During the actual detection, one can estimate the equivalent size of defect from this curve based on the measured defect distance and gain.
33. Coupling: action that transmits acoustic wave between the probe and the inspected part.
34. Test block: a sample for determining the features and the detecting sensitivity of an ultrasonic detection system.
35. Standard test block: a test block whose material, shape and size are calibrated by a body in charge or authoritative institute. It is used for testing the performance and adjusting sensitivity of an ultrasonic detection unit or system.
36. Comparing test block: the test block used for adjusting the sensitivity of an ultrasonic detection system or comparing the defect. Generally it is made of the material similar with the material to be detected.
37. Probe: electric-sound converting component for sending or receiving (or both) ultrasonic energy. This kind of device normally consists of trademark, plug, casing, back lining, piezoelectric component, protective film or wedge.
38. Straight probe: a probe for vertical flaw detection, which is mainly for detecting longitudinal wave.
39. Angle probe: a probe for angle-sending flaw detection, which is mainly for detecting transversal wave.

twilight

INSTRUMENTOS DE MEDICIÓN INDUSTRIAL



LLÁMANOS

+52(81) 8115-1400 / +52 (81) 8173-4300

LADA Sin Costo:
01 800 087 43 75

E-mail:
ventas@twilight.mx

www.twilight.mx



/ [twightsadecv](https://www.facebook.com/twightsadecv)



/ [twightsadecv](https://twitter.com/twightsadecv)



/ [twightsadecv](https://www.youtube.com/twightsadecv)