

MASTECH®

MS2026
MS2026R

DIGITAL CLAMP METER

Use's Manual

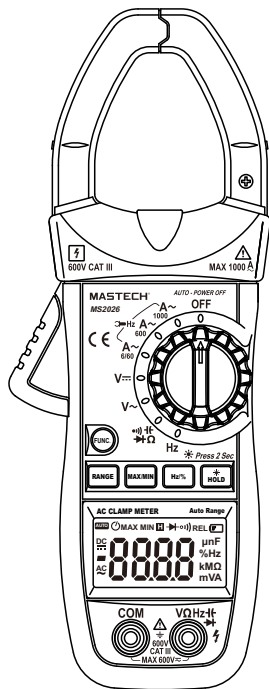

MASTECH®

CONTENTS

1. Safety Information.....	1
1.1 Preliminary.....	1
1.2 During Use.....	2
1.3 Symbols.....	3
1.4 Maintenance.....	3
2. Description.....	4
2.1 Names of Parts.....	5
2.2 Switch, Buttons and Input Jacks.....	7
2.3 LCD (Liquid-crystal display).....	8
3. Specifications.....	9
3.1 General Specifications.....	9
3.2 Technical Specifications.....	10
4. Operation Instruction.....	15
4.1 Holding Readings.....	15
4.2 Switching REL.....	15
4.3 Switching Frequency or Duty.....	15
4.4 Switching Maximum or Minimum Value.....	16

MASTECH®

CONTENTS

4.5 Switching Functions.....	16
4.6 Back Light and Clamp Lighting Bulb.....	17
4.7 Auto Power Off.....	18
4.8 Preparing for Measurement.....	18
4.9 Measuring AC Current.....	18
4.10 Measuring AC Voltage.....	19
4.11 Measuring DC Voltage.....	20
4.12 Measuring Frequency.....	21
4.13 Measuring Duty.....	23
4.14 Measuring Resistance.....	26
4.15 Testing Diode.....	27
4.16 Testing Continuity.....	28
4.17 Measuring Capacitance.....	29
5. Maintenance.....	30
5.1 Replacing The Batteries.....	30
5.2 Replacing Test Leads.....	30
6. Accessories.....	31

1. Safety Information

WARNING

BE EXTREMELY CAREFUL WHEN USING THIS METER. Improper use of this device can result in electric shock or destruction of the meter. Take all normal safety precautions and follow the safeguards suggested in this manual. To exploit full functionality of the meter and ensure safe operation, please read carefully and follow the directions in this manual.

This meter has been designed according to IEC-61010 concerning electronic measuring instruments with an overvoltage category CAT III 600V and pollution 2.

Follow all safety and operating instructions to ensure safe use of the meter.

With proper use and care, this digital multimeter will give you years of satisfactory service.

1.1 Preliminary

- 1.1.1 When using the meter, the user must observe all normal safety rules concerning:
 - General protection against electric shock
 - Protection of the meter against misuse
- 1.1.2 When the meter is delivered, check whether it has been damaged in transit.
- 1.1.3 After being stored and delivered under harsh conditions, the meter should be checked and confirmed whether any damages have been incurred.
- 1.1.4 Test leads must be kept in good condition. Before using check whether the insulation on test leads has been damaged and any wire has been exposed.





- 1.1.5 Use the test leads supplied to ensure operation safety. If required, they must be replaced with test leads of the same model or class.

1.2 During Use

- 1.2.1 Use the right input jack, function and range.
- 1.2.2 Do not take measurements that exceed the protection limit values indicated in the specifications.
- 1.2.3 Do not touch the metal tips of the test leads when the meter is connected to the circuit to be measured.
- 1.2.4 Keep your fingers behind the probe barriers when taking a measurement with an effective voltage above 60V DC or 30V rms AC.
- 1.2.5 Do not take voltage measurement if the value between the terminals and earth ground exceeds 600V.
- 1.2.6 Select the highest range if the value scale to be measured in the manual range is unknown.
- 1.2.7 Disconnect the test leads from the circuit under test before turning the rotary selector to change functions.
- 1.2.8 Do not measure the resistance, capacitance, diode or continuity of live circuits.
- 1.2.9 Do not connect the meter to any voltage source while the rotary selector is in the current, resistance, capacitance, diode or continuity range.
- 1.2.10 Do not take capacitance measurements until the capacitor to be measured has been fully discharged.
- 1.2.11 Do not use the meter near explosive gases, steam or dirt.

- 1.2.12 Stop using the meter if any abnormalities or faults are observed.
- 1.2.13 Do not use the meter unless its rear case and battery cover is securely fastened in its original position.
- 1.2.14 Do not store or use the meter in areas exposed to direct sunlight, at high temperature or with high relative humidity.

1.3 Symbols

	Note-Important safety information, refer to the instruction manual.
	Application around and removal from UNINSULATED HAZARDOUS LIVE conductors is permitted.
	Caution, possibility of electric shock
	Equipment protected throughout by double insulation or reinforced insulation.
	Earth (ground) TERMINAL

CAT III: MEASUREMENT CATEGORY III is applicable to test and measuring circuits connected to the distribution part of the building's low-voltage MAINS installation.

1.4 Maintenance

- 1.4.1 Do not attempt to remove the rear case to adjust or repair the meter. Such actions should only be performed by a technician who fully understands the meter and the danger involved.
- 1.4.2 Before opening the case and battery cover of the meter, always disconnect test leads from all sources of electric current. Disconnect the test leads from all sources of electric current before opening the rear case and battery cover of the meter.

- 1.4.3 To avoid any electric shock caused by error readings, replace the batteries immediately when the "☐" sign appears on the display.
- 1.4.4 Use damp cloth and mild detergent to clean the meter; do not use abrasives or solvents.
- 1.4.5 Turn the rotary selector to OFF position to switch off the power when the meter is not in use.
- 1.4.6 Remove the batteries to avoid damages to the meter if it will idle for a long time.

2. Description

- This meter is a portable professional measuring instrument with LCD and back light easily reading. The 'single-hand operation' design for the range switch makes measurement simple and easy. Overload protection and low battery indication are provided. It is an ideal multi-function Instrument with scores of practical applications for professional, workshop, school, hobby and home use.
- The meter can perform measurements of AC/DC voltage and AC current, resistance, frequency, duty, capacitance, as well as continuity and diode test.
- auto range is available.
- This meter is equipped with reading hold function.
- This meter is equipped with square value measuring function (at AC A and AC V range).
- This meter is equipped with maximum value measuring function.
- This meter is equipped with minimum value measuring function.
- This meter can measure frequency by clamp.
- This meter has function of auto power off.

2.1 Names of Components

- (1) Current Clamp
- (2) Clamp Lighting Bulb
- (3) Panel
- (4) Trigger
- (5) Function Switch Button (FUNC)
- (6) MAX/MIN Switch Button (MAX/MIN)
- (7) manual Button (RANGE)
- (8) Liquid Crystal Display (LCD)
- (9) COM Jack
- (10) Input Jack
- (11) Hz/Duty Switch Button (Hz/%)
- (12) Reading Hold/Back Light Button (HOLD/B.L)
- (13) Rotary selector
- (14) OFF - power switch
- (15) "+" Symbol
- (16) "-" Symbol
- (17) Rear Case
- (18) Fixing Screw of Battery Cover
- (19) Battery Cover

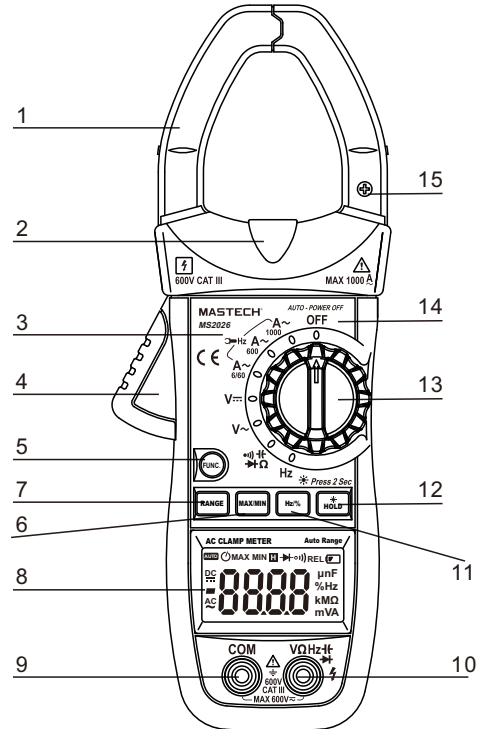

2.2 Switch, Buttons and Input Jacks

HOLD/B.L Button

- For holding the reading or control back light

FUNC Button

- For switching among measuring functions

RAN Button

- The key is the Auto/Manual measurement key.

Hz/% Button

- For switching between frequency and duty measuring functions.

MAX/MIN Button

- For switching between maximum and minimum value measuring function.

Rotary Selector

- For selecting functions and ranges.

OFF Position

- for turning off the power.

INPUT Jack

- For measuring voltage, resistance, frequency, duty, capacitance, diode, and continuity.

COM Jack

- Common input connection for current, voltage, resistance, frequency, duty, capacitance, diode, continuity measurement.

Clamp

- For measuring current

2.3 LCD (Liquid-crystal display)

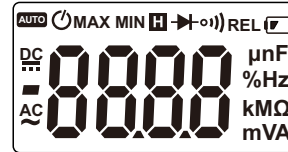

AC	ALTERNATING CURRENT
DC	Direct current
→ 	Diode test
o)	Continuity buzzer
AUTO	Auto range mode
MAX	The maximum value is being measured
MIN	The minimum value is being measured
REL	DCA zero and relative measure
⏻	Auto power off
🔋	Battery low
H	This indicates that the display data is being held.
%	Percent (Duty cycle)
mV, V	Milli-volts, Volts (Voltage)
A	Amperes (Current)
nF, μF	Nanofarad, Microfarad
Ω, kΩ, MΩ	Ohms, Kilo-ohms, Mega-ohms (Resistance)
Hz, kHz, MHz	Hertz, Kilo-hertz (Frequency), Milohertz

3. Specifications

Calibration is required once a year, to be carried out at a temperature between 18°C and 28 °C (64°F to 82°F) and relative humidity below 75%.

3.1 General Specifications

- 3.1.1 Auto range.
- 3.1.2 Overrange protection is provided for all ranges.
- 3.1.3 Maximum voltage between terminals and earth ground: 600V DC or 600V rms AC
- 3.1.4 Operating altitude: max. 2000 meters (7000 ft.)
- 3.1.5 Display: 6000 counts.
- 3.1.6 Maximum value display: 6000 digits
- 3.1.7 Polarity indication: automatic; '-' for negative polarity.
- 3.1.8 Overrange indication: '0L' or '-0L'
- 3.1.9 Converter Rate: 3 times/sec;
- 3.1.10 Unit indication: function and unit.
- 3.1.11 Auto power off time: 15 minute.
- 3.1.12 Operating power : 1.5V×3 AAA batteries
- 3.1.13 Battery low indication: '▣' on LCD
- 3.1.14 Temperature factor: < 0.1×Accuracy /°C
- 3.1.15 Operating temperature: 0°C to 40°C (32°F to 104°F)
- 3.1.16 Storage temperature: -10°C to 50°C (10°F to 122°F)
- 3.1.17 Dimension: 225×86×33mm
- 3.1.18 Weight: approximate 320g (including batteries)

3.2 Electrical Specifications

Ambient temperature: 23±5°C Relative humidity: < 75%

3.2.1 AC Current

Range	Resolution	Accuracy
6A	0.001A	±(2.0% of rdg + 6 digits)
60A	0.01A	
600A	0.1A	
1000A	1A	

- Max. input current: 1000AAC
- Frequency range: 40 to 100Hz

3.2.2 DC Voltage

Range	Resolution	Accuracy
600mV	0.1mV	±(0.7% of rdg + 3digits)
6V	0.001V	
60V	0.01V	
600V	0.1V	
750V	1V	±(0.8%rdg+2dgt)

- Input impedance: 10MΩ
- Max. input voltage: 600V DC or 600V AC

Note:

At small voltage range, unsteady readings will appear before the test leads contact the circuit. This is normal because the meter is highly sensitive. When the test leads contact the circuit, the true reading will be shown.

3.2.3 AC Voltage

Range	Resolution	Accuracy
6V	0.001V	±(0.8% of rdg + 3digits)
60V	0.01V	
600V	0.1V	
750V	1V	±(1% of rdg+4digits)

- Input impedance: 10MΩ
- Max. input voltage: 600V DC rms 600V AC
- Frequency range: 40 to 400Hz

3.2.4 Frequency

3.2.4.1 By A range (from current clamp):

Range	Resolution	Accuracy
99.99Hz	0.01Hz	±(1.5% of rdg + 5 digits)
999.9Hz	0.1Hz	
>1KHz	0.001KHz	

- Measurement range: 10Hz~10kHz
- Input current range: ≥6A rms AC (higher input current at higher frequency)
- Max. Input current: 1000A rms AC

3.2.4.2 By ACV range:

Range	Resolution	Accuracy
99.99Hz	0.01Hz	±(1.5% of rdg + 5 digits)
999.9Hz	0.1Hz	
9.999KHz	0.001KHz	
>10KHz	0.01KHz	Take it only as reference

- Measurement range: 10~10kHz
- Input voltage range: ≥0.6V rms AC (higher input voltage at higher frequency)
- Input impedance: 10MΩ
- Max. input voltage: 600V rms AC

3.2.4.3 By Hz/DUTY range

Range	Resolution	Accuracy
9.999Hz	0.001Hz	±(0.3% of rdg + 5 digits)
99.99Hz	0.01Hz	
999.9Hz	0.1Hz	
9.999KHz	0.001KHz	
99.99KHz	0.01KHz	
999.9KHz	0.1KHz	
9.999MHz	0.001MHz	

- Overload protection: 250V dc or 250V ac rms.
- Input Voltage range: 200mV-10V ac rms

3.2.5 Duty Cycle

Range	Resolution	Accuracy
0.1%-99%	0.1%	±3%

3.2.5.1 By A range (from current clamp):

- Frequency response: 10~1kHz
- Input current range: ≥ 6A rms AC
- Max. input current: 1000A

3.2.5.2 By ACV range:

- Frequency response: 10~10 kHz
- Input voltage range: ≥ 0.6 V rms AC
- Input impedance: 10M Ω
- Max. input voltage: 600V rms AC

3.2.5.3 By Hz/DUTY range

- Frequency response: 10~10MHz
- Input voltage range: ≥ 0.2 V AC
- Overload protection: 250V rms AC

3.2.6 Resistance

Range	Resolution	Accuracy
600 Ω	0.1 Ω	$\pm(0.8\%$ of rdg + 3 digits)
6k Ω	0.001k Ω	
60k Ω	0.01k Ω	
600k Ω	0.1k Ω	$\pm(1.2\%$ of rdg + 3 digits)
6M Ω	0.001M Ω	
60M Ω	0.1M Ω	

- Open circuit voltage: 0.4V
- Overload protection: 250V DC or rms AC

3.2.7 Diode

Range	Resolution	Function
	0.001V	Displaying approximate forward voltage of diode

- Forward DC current~1mA
- Reversed DC voltage~3.3V
- Overload protection: 250V DC or rms AC

3.2.8 Continuity

Range	Resolution	Function
	0.1 Ω	Built-in buzzer will sound, if resistance is lower than 50 Ω .

- Overload protection: 250V DC or rms AC

3.2.9 Capacitance

Range	Resolution	Accuracy
40nF	0.01nF	$\pm(4.0\%$ of rdg + 5 digits)
400nF	0.1nF	
4 μ F	0.001 μ F	
40 μ F	0.01 μ F	
400 μ F	0.1 μ F	
4000 μ F	1 μ F	

- Overload protection: 250V DC or rms AC

4. Operation Instruction

4.1 Holding Readings

- 4.1.1 Press the “**HOLD/B.L**” button to hold the readings while taking measurement and the value on the display will be held.
- 4.1.2 Press the “**HOLD/B.L**” button again to release the reading hold function.

4.2 Switching Manual or Auto Mode

Range key is the Auto/Manual measurement key that acts with trigger. Auto measurement is pre-set as power-on, and switches to Manual measurement when the key is pressed one time. In Manual measurement mode, mode will move upward upon each press to the highest mode, then return to the lowest mode as a loop. If press the key over 2 seconds, the system will switch back to Auto measurement status.

4.3 Switching Frequency or Duty

- 4.3.1 During working at the voltage or current ranges, press the “**Hz/%**” button one time, frequency of the voltage or current will be measured. Press the “**Hz/%**” button twice, the meter will be changed into the duty range for measuring the duty cycle of the voltage or current. At the same time, the meter is changed into manual mode.
- 4.3.2 Press the “**Hz/%**” button again, meter will be back to the condition of the voltage or current measuring.

Note:

During working at maximum or minimum value measuring function, the meter can't be changed into frequency or duty cycle measuring mode.

4.4 Switching Maximum or Minimum Value

- 4.4.1 At all ranges, press the “**MAX/MIN**” button one time, the meter can be set to maximum value measuring mode; press the button twice, the meter can be set to minimum value measuring mode; press the button three times, the meter will get back to normal test mode, and the maximum and minimum value will be recorded by the chip.
- 4.4.2 Press the “**MAX/MIN**” button more than two second , the meter will get back to normal test.

Note:

- 1) During measuring maximum or minimum value, the meter will be set to manual mode automatically.
- 2) During working at frequency or duty measuring function, the meter can't be changed into maximum or minimum value measuring mode.

4.5 Switching Functions

- 1) SELECT Key is a function selection key that acts with trigger. Press the key can choose the needed measurement mode: To choose DC or AC in DC/AC status, to choose Diode or Buzzer in Diode/Buzzer status, to choose Ohm, Cap, Diode or Buzzer in Ohm/Cap/Diode/ Buzzer status.
- 2) Press the key then turn on the power, the Auto Power-off function will be cancelled, the signal “” disappears in LCD, and enter into Sleep Status (Power-Off). Press the key then power on will have the Auto Power-Off function.

4.6 Back Light and Clamp Lighting Bulb

- 4.6.1 Press the “HOLD/B.L” button for two or more seconds to switch on the back light if the light in the environment is too dim for taking reading, which will last for 15 seconds.
- 4.6.2 During the back light is working, press the “HOLD/B.L” button for two or more seconds, it will be turned off.
- 4.6.3 At the current range, when the back light is switched on, the clamp lighting bulb will be turned on at the same time.

Note:

- LED which requires a larger working current, is the main source of back light. Although the meter is equipped with a timer set at about 15 seconds (i.e. the back light will be off automatically after about 15 seconds), frequent use of the back light will shorten the life of the batteries. Therefore, do not use the back light unless necessary.
- When the battery voltage is $\leq 3.7V$, the symbol “

17

4.7 Auto Power Off

- 4.7.1 If the mode switch or keys of the meter is no action within 15 minutes, the system will power off automatically (sleep mode). In Auto Power-off status, press any key, the meter will “Auto Power-On” (Operation Mode)

4.8 Preparing for Measurement

- 4.8.1 Switch on the power by turning the rotary selector. If the battery voltage is lower than 3.7V, the “

4.9 Measuring AC Current

WARNING

Beware of Electrocution.
Ensure that the test leads are disconnected from the meter before making current clamp measurements.

- 4.9.1 Set the rotary selector to the **A~** range position.
- 4.9.2 Press the trigger to open jaw. Fully enclose only one conductor.
- 4.9.3 Take the reading on the LCD.

Note:

- 1) Do not put more than one cable into the jaw during test, otherwise incorrect test value might be obtained.
- 2) For optimum results, center the conductor in the jaw.
- 3) At the manual range mode, when only 'OL' is shown on the LCD, it means the measurement has exceeded the range. A higher range should be selected.
- 4) If the scale of the value to be measured is unknown beforehand, set the range to the highest.
- 5) "⚠" means the maximum input current is 1000A rms AC.

4.10 Measuring AC Voltage

⚠ WARNING

Beware of Electrocutation.
Pay special attention to avoid electric shock when measuring high voltage.
Do not input the voltage which more than 600V rms AC.

- 4.10.1 Plug the black test lead into the **COM** jack and the red test lead into the **INPUT** jack.
- 4.10.2 Set the rotary selector to **V~** position to make the meter get into AC V range.
- 4.10.3 Connect the test leads to the voltage source or load terminals for measurement.
- 4.10.5 Take the reading on the LCD.

Note:

- 1) "⚠" means the maximum input voltage is 750V rms AC.
- 2) If the test result is more than 750V rms AC, symbol "OL" will be displayed on LCD and the build-up buzzer will sound.

4.11 Measuring DC Voltage

⚠ WARNING

Beware of Electrocutation.
Pay special attention to avoid electric shock when measuring high voltage.
Do not input the voltage which more than 600V DC.

- 4.11.1 Plug the black test lead into the **COM** jack and the red test lead into the **INPUT** jack.
- 4.11.2 Set the rotary selector to at the **V=** range position.
- 4.11.3 Connect the test leads to the voltage source or load terminals for measurement.
- 4.11.4 Take the reading on the LCD. The polarity symbol denotes the polarity of the end connected by the red test lead.

Note:

- 1) At small voltage range, unsteady readings will appear before the test leads contact the circuit. This is normal because the meter is highly sensitive. When the test leads contact the circuit, the true reading will be shown.
- 2) "⚠" means the maximum input voltage is 600V DC.
- 3) If the test result is more than 1000V DC, symbol "OL" will be displayed on LCD and the build-up buzzer will sound.

4.12 Measuring Frequency

4.12.1 By A range (from current clamp):

⚠ WARNING

Beware of Electrocutation.
Ensure that the test leads are disconnected from the meter before making current clamp measurements.

- 4.12.1.1 Set the rotary selector to the **A** range position.
- 4.12.1.2 Press the trigger to open jaw. Fully enclose only one conductor.
- 4.12.1.3 Press the “**Hz/%**” to switch to the frequency measurement.
- 4.12.1.4 Take the reading on the LCD.

Note:

- 1) Do not put more than one cable into the jaw during test, otherwise incorrect test value might be obtained.
- 2) Frequency test range is 10Hz-1kHz. '00.0' will be displayed on LCD if the test frequency is lower than 10.0 Hz. It is possible to test the frequency which is higher than 1 kHz but the tolerance of the test result can not be ensure.
- 3) “**⚠**” means the maximum input current is 400A rms AC.

4.12.2 By V range:

⚠ WARNING

Beware of Electrocutation.
Pay special attention to avoid electric shock when measuring high voltage. Do not input the voltage which more than 750V rms AC.

- 4.12.2.1 Plug the black test lead into the **COM** jack and the red test lead into the **INPUT** jack.
- 4.12.2.2 Set the rotary selector to the **V~** range position.
- 4.12.2.3 Press the “**Hz/%**” key to switch to frequency measurement.
- 4.12.2.4 Connect test leads to the two ends of the source or load for measurement.
- 4.12.2.5 Take the reading on the LCD.

Note:

- 1) Frequency test range is 10Hz -10kHz. It is possible to test the frequency which is higher than 10kHz but the tolerance of the test result can not be ensure.
- 2) “**⚠**” means the maximum input voltage is 750V rms AC.

4.12.3 By HZ/DUTY range:

⚠ WARNING

Beware of Electrocutation. Pay special attention to avoid electric shock when measuring high voltage. Do not input the voltage which more than 250V rms AC.

- 4.12.3.1 Plug the black test lead into the **COM** jack and the red test lead into the **INPUT** jack.
- 4.12.3.2 Set the rotary selector to the **HZ/DUTY** range position.
- 4.12.3.3 Connect test leads to the two ends of the source or load for measurement.
- 4.12.3.4 Take the reading on the LCD.

4.13 Measuring Duty

4.13.1 By A range (from current clamp):

WARNING

**Beware of Electrocution.
Ensure that the test leads are disconnected
from the meter before making current clamp
measurements.**

- 4.13.1.1 Set the rotary selector to the **A** range position.
- 4.13.1.2 Press the trigger to open jaw. Fully enclose only one conductor.
- 4.13.1.3 Press the “**Hz/%**” to switch to the DUTY measurement.
- 4.13.1.4 Take the reading on the LCD.

Note:

- 1) Do not put more than one cable into the jaw during test, otherwise incorrect test value might be obtained.
- 2) If the duty cycle is less than 10%, symbol 'UL' will be displayed on LCD; if the duty cycle is more than 94.9%, symbol 'OL' will be displayed on LCD.
- 3) The input signal frequency range is 10-1kHz. It is possible to test duty cycle of the higher than 1 kHz frequency signal, but the tolerance of the test result can not be ensure.
- 4) “

23

4.13.2 By V range:

WARNING

**Beware of Electrocution.
Pay special attention to avoid electric shock
when measuring high voltage.
Do not input the voltage which more than
600V rms AC.**

- 4.13.2.1 Plug the black test lead into the **COM** jack and the red test lead into the **INPUT** jack.
- 4.13.2.2 Set the rotary selector to the **V~** range position.
- 4.13.2.3 Press the “**Hz/%**” to switch to DUTY measurement.
- 4.13.2.4 Connect test leads to the two end of the source or load for measurement.
- 4.13.2.5 Take the reading on the LCD.

Note:

- 1) If the duty cycle is less than 10%, symbol 'UL' will be displayed on LCD; if the duty cycle is more than 94.9%, symbol 'OL' will be displayed on LCD.
- 3) The input signal frequency range is 10 – 100 kHz. It is possible to test duty cycle of the higher than 100 kHz frequency signal, but the tolerance of the test result can not be ensure.
- 3) “

24

4.13.3 By HZ/DUTY range:



WARNING

Beware of Electrocutation. Pay special attention to avoid electric shock when measuring high voltage. Do not input the voltage which more than 250V rms AC.

- 4.13.3.1 Plug the black test lead into the **COM** jack and the red test lead into the **INPUT** jack.
- 4.13.2.2 Set the rotary selector to the **HZ/DUTY** range position.
- 4.13.2.3 Press the “Hz/%” to switch to DUTY measurement.
- 4.13.2.4 Connect test leads to the two end of the source or load for measurement.
- 4.13.2.5 Take the reading on the LCD.

Note:

- 1) If the duty cycle is less than 10%, symbol 'UL' will be displayed on LCD; if the duty cycle is more than 99.9%, symbol 'OL' will be displayed on LCD.

4.14 Measuring Resistance



WARNING

Beware of Electrocutation. When measuring in-circuit resistance, make sure that the power of the circuit under test has been turned off and that all capacitors have been fully discharged.

- 4.14.1 Plug the black test lead into the **COM** jack and the red test lead into the **INPUT** jack.
- 4.14.2 Set the rotary selector to the **Ω** range position to make the meter get into Ω range.
- 4.14.3 Connect the test leads to the ends of the resistor or circuit for measurement.
- 4.14.4 Take the reading on the LCD.

Note:

- 1) When the input is open, 'OL' will appear on the LCD to indicate that the range has been exceeded.
- 2) For measuring resistance above 1MΩ, it may take a few seconds to get a steady reading. This is normal for high resistance reading.

4.15 Testing Diode

- 4.15.1 Plug the black test lead into the **COM** jack and the red test lead into the **INPUT** jack.
- 4.15.2 Set the rotary selector to the $\rightarrow \text{di}$ range position.
- 4.15.3 Press the “**SEL**” button to switch to $\rightarrow \text{di}$ test.
- 4.15.4 Connect the red test lead to the anode and the black test lead to the cathode of the diode for testing.
- 4.16.5 Take the reading on the LCD.

Note:

- 1) The meter will show the approximate forward voltage drop of the diode.
- 2) When the test leads have been reversed or open, 'OL' will appear on the LCD.

4.16 Testing Continuity

WARNING

Beware of Electrocutation.

Make sure that the power of the circuit has been turned off and the capacitors have been fully discharged before testing the continuity of a circuit.

- 4.16.1 Plug the black test lead into the **COM** jack and the red test lead into the **INPUT** jack.
- 4.16.2 Set the rotary selector to the $\rightarrow \text{di}$ range position.
- 4.16.3 Press the "SEL" button to switch to $\rightarrow \text{di}$ continuity test.
- 4.16.4 Connect the test leads to the two ends of the circuit for measurement.
- 4.16.5 If the resistance of the circuit being tested is less than 50Ω , the built-in buzzer will maybe sound.
- 4.16.6 Take the reading on the LCD.

Note:

If the test leads are open or the resistance of the circuit is over 600Ω , "OL" will appear on the LCD.

4.17 Measuring Capacitance

 **WARNING**

Beware of Electrocutation.

To avoid electric shock, make sure that the capacitors have been fully discharged before measuring the capacitance of a capacitor.

- 4.17.1 Plug the black test lead into the **COM** jack and the red test lead into the **INPUT** jack.
- 4.17.2 Set the rotary selector to the $\rightarrow \frac{\mu}{F}$ range position.
- 4.17.3 After fully discharged the capacitor, connect the test leads to the two ends of the capacitor for measurement.
- 4.18.4 Take the reading on the LCD.

Note:

- 1. It may take some time (about 30 seconds for the $400\mu F$ and $4000\mu F$ range) for steady readings when measuring high capacity.

5. Maintenance

5.1 Replacing The Batteries

 **WARNING**

To avoid electric shock, make sure that the test leads have been clearly move away from the circuit under measurement before opening the battery cover of the meter.

 **WARNING**

Do not mix old and new batteries. Do not mix alkaline, standard (carbon-zinc), or rechargeable (ni-cad, ni-mh, etc) batteries.

- 5.1.1 If the sign “” appears, it means that the batteries should be replaced.
- 5.1.2 Loosen the fixing screw of the battery cover and remove it.
- 5.1.3 Replace the exhausted batteries with new ones.
- 5.1.4 Put the battery cover back and fix it again to its origin form.

Note:

Do not reverse the polarity of the batteries.

5.2 Replacing Test Leads

Replace test leads if leads become damaged or worn.

 **WARNING**

Use meet EN 61010-031 standard, rated CAT III 600V, or better test leads.

6. Accessories

- 1) Test Leads: Electric Ratings 1000V 10A 1 pair (set)
- 2) Operating Manual 1 copy
- 3) 1.5V AAA Battery 3 piece

