

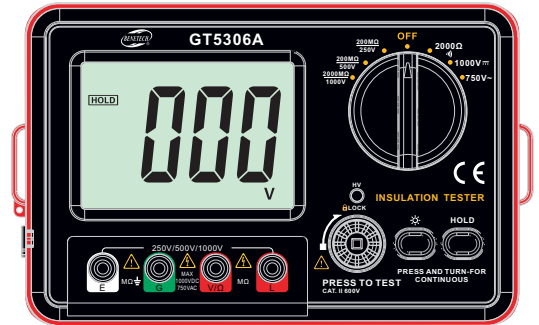

MODEL: **GT5306A**

## INSULATION RESISTANCE TESTER Instruction Manual



Standard: Q/GMY 027—2020  
Version: 5306A-EN-02

# Content

## I . Important Notice Before Use

Inspection .....	01
Safety Instructions .....	02
Introduction .....	04
Features .....	04
Description of parts .....	05
Specifications .....	06
LCD Display .....	08

## II . Operating Instructions

Insulation Resistance Measurement .....	09
Resistance and Continuity Measurement .....	10
DC Voltage Measurement .....	10
AC Voltage Measurement .....	11
Data HOLD .....	11
Backlight .....	11

## III . Other Notes

Cautions .....	12
Battery replacement .....	12
Fuse replacement .....	12
Trouble shooting .....	13
Maintenance and Warranty .....	13

## I . Important Notice Before Use

### Inspection

Thanks for buying the Insulation Resistance Tester produced by our company. Please open the package and inspect the following components. Please contact with the seller if any component is missing or the manual's page fault is too serious to read.

○ Insulation Resistance Tester	1PCS
○ 1.5V AA Size Batteries	6PCS
○ 10A Test Pen	1PCS
○ Crocodile Clip	1PCS
○ Instruction Manual	1PCS
○ Strap	1PCS
○ Cloth Bag	1PCS

## Safety Instructions

In order to use this tester properly, please read this manual carefully before use. This instruction manual includes warning messages and safety regulations. Please strictly abide by these regulations to ensure the safety of the users and the tester.

Notes:

1. Please read and comprehend the information included in this manual before using this instrument.
2. Please use this instrument in strict accordance with the test procedures described in this manual.
3. Please learn the content of the security aspect in this manual in detail.
4. This tester can only be operated by formally-trained and qualified technicians and must be used under the conditions specified in this manual.
5. The company will not be responsible for the equipment damage and other loss caused by misuse or violation of the safe operation regulations in this manual.

The security symbol "⚠" has three meanings in this manual. Please pay special attention to the symbol "⚠" when reading the manual.

⚠ Danger-to avoid serious or fatal damage that may be caused by operation under certain conditions.

⚠ Warning-to avoid the danger of electric shock.

⚠ Attention-to avoid damage to the instrument and make accurate measurements.

### ⚠ Danger

- Never measure AC circuit with a voltage above 600V.
- Please do not test in flammable environment for the spark may cause explosion.
- Please do not operate the instrument if the surface of the instrument is wet or the operator's hands are wet.

- Do not touch the conductive part of the test pen during measurement.
- Please do not open the battery cover during measurement.
- Do not touch the circuit to be measured when measuring the insulation resistance.



### ⚠ Warning

- Please stop using the instrument if there is any abnormality. E.g. The instrument is damaged or its metal portion is exposed.
- Please do not replace battery if the instrument is wet.
- Please make sure that all the test leads are firmly connected with the instrument's test interfaces.
- Please turn off the instrument before opening the battery cover.
- Please read and comprehend the manual carefully before using the instrument.
- Please comply with the requirements of the manual whenever possible. Please keep the manual so that it can be available for reference at any time.
- Wrong operation may cause accidents and damage to the instrument when testing the instrument.

### ⚠ Attention

- Before measuring insulation resistance, the electric circuit to be measured must be fully discharged and completely isolated from other power circuits.
- If the test pen is damaged and needs replacing, it must be replaced with a test pen with the same type and the same specifications.
- Do not use the instrument when the battery indicator (🔋) indicates that electric energy is used up. Please take the batteries out and store them if the instrument has not been used for a long time.
- Please do not store or use this instrument in the environment of high temperature, high humidity, flammability, explosiveness, and strong electromagnetic field.

The meaning of the symbols related to this instrument:

ACV	Alternating Current (AC) Voltage
	Grounding
	The instrument has double insulation or reinforced insulation

Application standard of this instrument:

IEC 61010-1 CATIII 600V

CAT I 2500V

## Introduction

This instrument applies DC voltage converter with low loss, high variation ratio, and inductive energy storage, which can convert 9V voltage to 250V/1000V DC voltage; it applies digital electric bridge to measure insulation resistance; it has functional characteristics of portability, wide measuring range, backlight display, and data holding; it can measure electric supply as well. When using straps, the operator can operate the instrument with both hands. The instrument has a fashionable appearance and stable performance. It is suitable for measuring electrical machinery, cable, electromechanical equipment, telecom equipment, electric power facilities and other insulation resistance.

## Features

1. Insulation Resistance Measurement
2. Alternating Current (AC) Measurement
3. Direct Current (DC) Measurement
4. Small Resistance Measurement
5. Measured Data Holding
6. Low Battery Indication
7. Large LCD digital display
8. External Direct Current (DC) power supply DC9V 1.5A
9. Over-limit Alarm
10. Red Alarm Light, Buzzer Alarm
11. High Voltage Alarm

## Description of parts

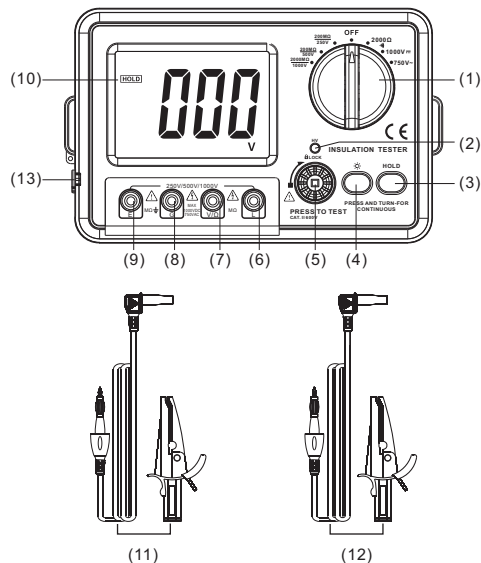

- (1) Power switch/function switch: power ON/OFF the instrument and selects functions. To save power, please turn the switch to "OFF" when it isn't in use.
- (2) High voltage indicator (LED)
- (3) HOLD button: hold the current reading. Press this button, the current reading will be held on the screen and the [HOLD] symbol will appear on the screen. Press this button again to cancel this function.
- (4)  button: Turn on/off backlight.

- (5) TEST button  
 (6) L: connected to the jack of the tested circuit's ground end.  
 (7) Input positive end of input voltage test, resistance below 2k $\Omega$ , and continuity test (V/ $\Omega$ ).  
 (8) G: jack of the protection end; when the tested object is required to add a protection ring to eliminate the leakage effect, the electrode wire of the protection ring should be connected to the jack of "G" end; input negative end of voltage, resistance and continuity test (G).  
 (9) E: jack connect to the measured object  
 (10) LCD display screen  
 (11) Black test wire with crocodile clip  
 (12) Red test wire with crocodile clip  
 (13) DC 9V power adapter socket(  ): connect external power supply so as to supply power to the internal circuit.

## Specifications

### 1. Technical specifications

Technical specifications	Technical Index
Display	3.5 digit LCD, maximum reading "1999"
Over-limit Indication	When the upper limit is exceeded, only the top digit will display "1"
Sampling Rate	About 3 times/second
Allowable Altitude	<2000 meters
Additional temperature coefficient	0.15 $\times$ specified accuracy/ $^{\circ}$ C (<18 $^{\circ}$ C or >28 $^{\circ}$ C)
Operating Environment	For indoor use, pollution degree 2
Operation Environment	-15 $^{\circ}$ C~55 $^{\circ}$ C , relative humidity <75%RH
Storage Environment	-40 $^{\circ}$ C~60 $^{\circ}$ C , relative humidity <90%RH
Overload Protection	100mA/60V resettable fuse
Low Battery Indication	the symbol "  " appears on the screen
Power Supply	6 $\times$ 1.5V "AA" batteries or external DC 9V power supply

Current Consumption	No-load power consumption <300mW when testing
Size	176*110*77mm
Weight	580g (including battery)

### 2. Product Parameters

- (1) Accuracy:  $\pm$  (a%+least significant digit)  
 (2) Environment temperature to ensure accuracy: 23 $\pm$ 5 $^{\circ}$ C  
 (3) Relative humidity: <75%  
 (4) Calibration guarantee period: 1 year since the manufacture date  
 (5) Voltage input impedance: 1M $\Omega$   
 (6) AC voltage frequency response: 50~200Hz

Basic Function	Measuring Range	Basic Accuracy
Output Voltage	250V/500V/1000V	$\pm$ 10%
Test Current	250V(R=250k $\Omega$ )1mA 500V(R=500k $\Omega$ )1mA 1000V(R=1M $\Omega$ )1mA	$\pm$ 10%
Insulation Resistance	250V:1M $\Omega$ ~200M $\Omega$ 500V:1M $\Omega$ ~200M $\Omega$ 1000V:10M $\Omega$ ~2000M $\Omega$	$\pm$ (4% $\pm$ 2)
Short-circuit Current	<1.8mA	
Median Resistance	250V/500V:100M $\Omega$ 1000V:1000M $\Omega$	
Resistance, Continuity Test	0 $\Omega$ ~2K $\Omega$ , <50V buzzer will make a sound, Test Current: 1mA	$\pm$ (0.8% $\pm$ 6)
DC Voltage Measurement	0V~1000V	$\pm$ (0.5% $\pm$ 6)
AC Voltage Measurement	0V~750V	$\pm$ (1% $\pm$ 6)
Jack Position	Insulation Resistance: E and L Voltage, Resistance: V/ $\Omega$ and G	

Further explanation: Median resistance—the lower limit of resistance measurement to ensure that the voltage at both ends of the measurement is not less than 90% of the nominal value of the test voltage.

## LCD Display

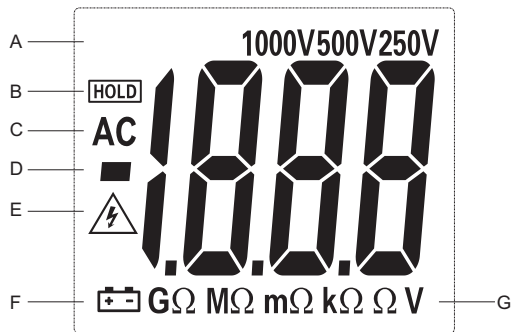

- A. Voltage Measuring Range
- B. Data Holding
- C. AC Voltage
- D. Measured Value
- E. High Voltage Indicator
- F. Low Battery Indicator
- G. Voltage/Resistance Unit

## II. Operating Instructions

When using the instrument for the first time or facing the energy shortage of the batteries, please open the cover of the battery box and put 6 5# batteries into it. Pay attention to the battery polarity. When external adapter is supplying power, the internal battery power will be cut off, and the battery cannot be charged at this time. Attention: Please choose the power supply mode (⊕→⊖).

## Insulation Resistance Measurement

1. Turn the knob to the position of the corresponding function in accordance with the measuring requirement.
2. Connect the electrode of tested object to the corresponding jack of the instrument.
3. Connect Jack G to the protection ring when testing the cable.
4. Press the test switch and the test will be carried out. When the display value is stable, the reading will be ready. Press the right knob to lock the continuous test, and turn the left knob to release the continuous test; when the test switch is pressed, the high voltage red warning light will light up, the high voltage symbol will appear on the screen, and the buzzer will sound "Di Di": when the measured insulation resistance is less than 5% of the range or short circuit, the buzzer will give a long sound warning.
5. Connect the red test pen "E" to the end of the measured circuit and the black test pen "L" to the GND end of the measured object; the lead "E" should be suspended in midair as far as possible.
6. If only "1" is displayed in the top digit, it means the measuring range is exceeded, and a higher range gear needs to be selected.

### Attention:

- (1) When the test switch is pressed, the output end "E" will output high voltage, please be careful.
- (2) When testing, check whether the selection of test voltage and the prompt of test voltage on LCD are consistent with the required voltage.
- (3) In MΩ test, the unstable reading may be caused by environmental interference or unstable insulation material. In this case, the "G" end can be connected to the shielded end of the tested object to stabilize the reading.

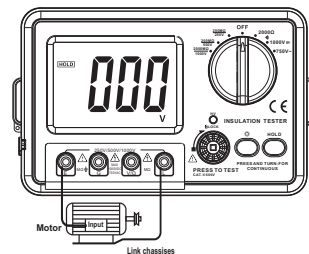

Diagram of the method to measure insulation resistance

## Resistance and Continuity Measurement

1. Turn the knob to the gear of 2000V.
2. Connect the red test pen to the "V/ $\Omega$ " input end, and connect the black test pen to the "G" input end.
3. Cross-connected the test rod to the circuit to be measured, and the data will display on the screen.
4. When the measured resistance is less than 50 $\Omega$ , the buzzer will make a sound.

### Attention:

- (1) If the resistance value exceeds 2K $\Omega$  or the open-circuit state occurs, "1" will be displayed on the screen.
- (2) When measuring online resistance, make sure that all the power supply of the measured circuit has been turned off and all the capacitance has been fully discharged before carrying out measurement.
- (3) Large errors that occur during measurement may be caused by the influence of other components online or the electric potential at both ends of the resistance.
- (4) Please do not input voltage in resistance measuring range.

## DC Voltage Measurement

1. Turn the knob to the gear of 1000V.
2. Connect the red test pen to the "V/ $\Omega$ " input end, and connect the black test pen to the "G" input end.
3. Cross-connect the test rod to the circuit to be measured. The voltage and polarity of the point to which the red test rod connects will be displayed on the screen.

### Attention:

- (1) If there is residual number on the screen when measurement has not started yet, it is a normal phenomenon which will not influence the measurement. If "1" is displayed on the top digit, it means the measuring range is exceeded.
- (2) Input voltage must not exceed DC 1000V. If so, the circuit of the instrument may be damaged.
- (3) When measuring high voltage circuit, be careful not to touch the high-voltage circuit.

## AC Voltage Measurement

1. Turn the knob to the gear of 750V
2. Connect the red test pen to the "V/ $\Omega$ " input end, and connect the black test pen to the "G" input end.
3. Cross-connect the test rod to the circuit to be measured. The voltage and polarity of the point to which the red test rod connects will be displayed on the screen.

### Attention:

- (4) If there is residual number on the screen when measurement has not started yet, it is a normal phenomenon which will not influence the measurement. If "1" is displayed on the top digit, it means the measuring range is exceeded.
- (5) Input voltage must not exceed AC 750V. If so, the circuit of the instrument may be damaged.
- (6) When measuring high voltage circuit, be careful not to touch the high-voltage circuit.

## Data HOLD

Press "HOLD" button, and the current data will be held on the screen; press the button again to cancel the data holding.

### Attention:

There is no such data holding function when measuring insulation resistance.

## Backlight

Press "☀" button, and the backlight will light up; press the button again, and the backlight will go out.

### III. Other Notes

#### Cautions

1. The object to be measured should be completely off-grid and be proved by short-circuit discharge that there is no electricity hazard before operation so as to ensure operation safety.
2. Do not connect DC voltage above 1000V or AC voltage above 750V to the instrument.
3. Do not measure the voltage value when the measuring range switch is at  $\Omega$  position.
4. Do not use the instrument when the batteries are not installed or the cover is not tightened.
5. Before replacing the batteries or the fuse, please remove the test rod from the test point and turn off the power switch.
6. Pay attention to the service condition of the 9V batteries. When the "  " symbol appears on the screen, please replace the batteries immediately.

#### Battery replacement

- (1) Use a screw driver to open the battery door's screws, and take off the battery door.
- (2) Take off the battery and replace it with a new one. To ensure long time battery power supply, it is recommended to use alkaline batteries.
- (3) Close the battery door and tighten the screws.

#### Fuse replacement

The instrument uses a 100mA/60V resettable fuse. In case of replacement, please use the fuse of same specification, and follow instructions as below:

- (1) Tune the function switch to "OFF" position.
- (2) Use a screw driver to loosen the screws on the bottom, and take off the bottom cover.
- (3) Remove the screws on the PCB, and take off the PCB.
- (4) Locate the resettable fuse on the PCB, which is marked with "FUSE". Use a soldering iron to take off the fuse and replace it with a new one of the same spec.

#### Trouble shooting

If the instrument does not work properly, the following self-check steps will help to solve general problems. If the fault still exists, please contact the maintenance or local distributor.

Fault	Solution
No display	1. Power off - please turn on the power; 2. Replace the batteries
"  " symbol appearance	Replace the batteries
Error value	Replace the batteries

#### Maintenance and Warranty

##### Maintenance:

1. Do not store the instrument in the following environment:
  - a. Places that are likely to be wet with water or gather dust;
  - b. Air with high salt or sulphur concentration;
  - c. Air with other gases or chemicals;
  - d. Places of high temperature, high humidity (60°C, above 90%RH), or direct sunlight.
2. Do not disassemble this instrument or try to change the interior.
3. Alcohol and diluent have corrosive effects on the outer shell, especially on the LCD window, so gently wipe the shell with a soft cloth dipped and a small amount of water when cleaning the outer shell.

##### Warranty:

1. Please refer to the warranty card for relevant warranty policy.
2. The company does not provide warranty service for equipment damage caused by users disassembling the product, improper transportation and storage after purchase, or failure to operate as required. The company also does not provide warranty service for those who alter the warranty card or do not have purchasing documents.



##### Special Statement:

- a. Used batteries must be disposed in accordance with local laws and regulations!
- b. The company does not assume legal responsibility for any derivative results of using the product.
- c. The company reserves the right to update and amend the product's design specification and manual content which are subject to change without prior notice.