

# MASTECH®

## MS2030

### AC Digital Clamp Meter User's Manual

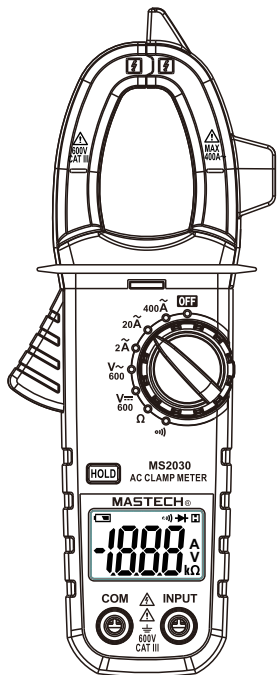

## CONTENTS

<b>1. Introduction .....</b>	<b>1</b>
<b>2. Safety Information.....</b>	<b>1</b>
2.1 Precautions .....	1
2.2 Safety Symbols.....	3
<b>3. Description.....</b>	<b>4</b>
3.1 Front Panel .....	4
3.2 Display .....	6
<b>4. Using the Meter .....</b>	<b>7</b>
4.1 Data Hold .....	7
4.2 DC Voltage .....	7
4.3 AC Voltage .....	7

## CONTENTS

4.4 AC Current.....	8
4.5 Resistance.....	8
4.6 Continuity .....	9
4.7 Diode Test .....	10
<b>5. Specifications .....</b>	<b>11</b>
5.1 General Specifications.....	11
5.2 Technical Specifications.....	11
<b>6. Maintenance.....</b>	<b>14</b>
6.1 General Maintenance .....	14
6.2 Replacing the Batteries.....	15
6.3 Replacing Test Leads.....	15
<b>7. Accessories .....</b>	<b>15</b>

## 1. Introduction

### WARNING

**Make sure to read and follow all safety procedures to avoid electric shock and/or injury.**

The MS2030 is a safe, reliable, yet small handheld 3 ½ digit digital clamp meter. Capable of measuring AC current, AC/DC voltage, resistance, diode's forward voltage drop, and continuity, it's ideal for both home users and professionals.

## 2. Safety Instructions

The MS2030 meets EN61010-1 safety requirements for electrical testing instruments and handheld digital multimeters. It's designed to comply with EN61010-1 with a CAT III 600V safety rating and pollution degree of 2.

- All safety guidelines outlined should be followed otherwise the protection provided by the instrument may be impaired.
- Warning symbols in the manual alert users of potential dangerous situations.
- Precautions are to prevent the user from damaging the instrument or the test object.







### 2.1 Precautions

To avoid possible electric shock, personal injury or damage to the meter, please observe the following:

1. Before using the meter, check the meter for damage during transport.
2. Check the test leads for damage to the insulation or wires before use.

3. Ensure the meter works properly by testing a known voltage first. If not working properly, have the meter serviced before using.
4. Never exceed the protection limit values indicated in the specifications for each range of measurement.
5. Always use caution when making voltage measurements above 60V dc or 30V ac rms.
6. Make sure to use the correct input jack, function and range when measuring.
7. Do not place the meter in any environment with dust, explosive gas or vapor.
8. Always keep fingers behind the probe barriers.
9. Connect the common test lead first, then the hot lead. Disconnect in reverse order.
10. Turn off power and discharge capacitors before measuring resistance, diodes or continuity.
11. Failure to follow safety guidelines may prevent the meter's built in protection from working properly.
12. To avoid damage or incorrect readings, check for AC voltage present before making DC voltage measurements.
13. Do not use the meter with the battery cover not securely in place.
14. When the "" symbol appears, replace the batteries to avoid incorrect readings
15. Before opening the case, always disconnect test leads from all energized circuits.
16. Only use the test leads provided with the meter. Replace only with similar leads with matching specifications.
17. Do not touch input jacks during measurement to avoid electric shock.
18. Before switching functions, remove test leads from an circuit.

## 2.2 Safety Symbols

	Note-Important safety information; refer to the instruction manual.
	Hazardous voltage may be present.
	Caution when testing on live conductors.
	Double insulation protection class II.
<b>CAT III</b>	This meter is in accordance with EN61010-1 standard overvoltage (insulation) category III, pollution degree 2.
	Complies with US and Canadian safety standards
	Complies with European (EU) safety standards
	Ground

**CAT III:** Applicable to test and measuring circuits connected to the distribution part of the building's low-voltage MAINS installation.  
Example: fixed equipment switchboards, circuit breakers, wiring, including cables, bus bars, junction boxes, switches, sockets, output terminals on devices for industrial use and other equipment.

**CAT II:** Applicable to test and measuring circuits connected directly to utilization points (socket outlets and similar points) of the low-voltage MAINS installation. Example: measurements on household appliances, portable tools and similar equipment.

**CAT 0:** Other circuits that are not directly connected to MAINS Example: surface mounted devices on a circuit board.

## 3. Description

### 3.1 Front Panel

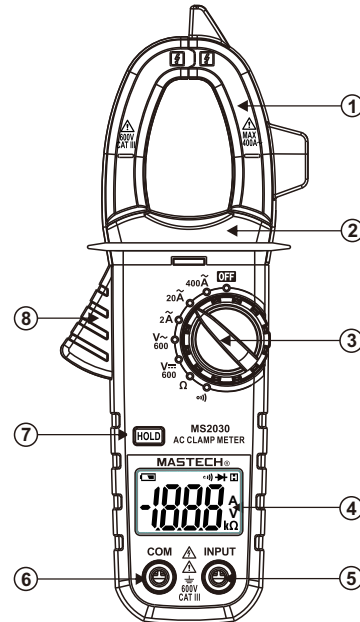

## 1. Current Clamp

For measuring AC current.

## 2. Safety barrier

Helps to keep hands from touching conductors while measuring current.

## 3. Rotary Switch

Used to select function and range.

## 4. Display

Max. display value: 1999

## 5. Input Jack

Connection for the live (red) test lead for voltage, resistance, diodes and continuity.

## 6. COM Jack

Connection for the common (black) test lead.

## 7. Hold Button

Press the "HOLD" button and the display will keep the reading on the screen. The "H" symbol appears on the display. Press the "HOLD" button again to return the display to normal.

## 8. Clamp Trigger

Press the trigger to open the clamp jaw; release to close.

## 3.2 Display

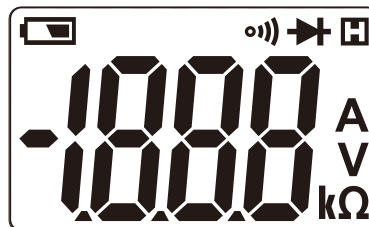

Symbol	Description
	Low Battery
<b>V</b>	Volts (Voltage)
<b>A</b>	Amps (Current)
<b>kΩ</b>	kilohms (Resistance)
	Continuity
	Diode
	Display Hold
	Polarity Indicator (Negative)

## 4. Using the Meter

### 4.1 Data Hold

The data hold function will keep the current reading on the display. To activate data hold:

1. Press the "HOLD" button and the reading will be held on the display. The "" symbol appears.
2. Press "HOLD" again to release the hold.

### 4.2 DC Voltage

1. Insert the red test lead in the "INPUT" jack and the black lead in the "COM" jack.
2. Move the rotary switch to the " $\sqrt{\sim}$  600" position. Connect the test leads across the circuit or load to be measured.
3. Read measured voltage on the display.

#### CAUTION

**Use extra caution when measuring high voltages to avoid electric shock or damage.**

#### WARNING

**Do not attempt to measure voltages above 600V DC to prevent injury or damage to the meter.**

### 4.3 AC Voltage

1. Insert the red test lead in the "INPUT" jack and the black lead in the "COM" jack.
2. Move the rotary switch to the " $\sqrt{\sim}$  600" position. Connect the test leads across the circuit or load to be measured.
3. Read measured voltage on the display.

#### CAUTION

**Use extra caution when measuring high voltages to avoid electric shock or damage.**

#### WARNING

**Do not attempt to measure voltages above 600V AC to prevent injury or damage to the meter.**

### 4.4 AC Current

1. Move the rotary switch to the  position with the proper range.
2. Press the trigger to open the clamp and insert one conductor inside the jaws. Only clamp one conductor; multiple conductors with different current directions will cancel out readings.
3. Read measured current on the display.

#### CAUTION

1. If the current range is not known before hand, set the range to the highest range and adjust down as necessary.
2. When measuring bare wires, use extra caution to avoid electric shock.

### 4.5 Resistance

1. Turn off all power and discharge capacitors on the circuit under test.
2. Insert the red test lead in the "INPUT" jack and the black lead in the "COM" jack.
3. Move the rotary switch to the  position. Connect the test leads across the circuit to be measured.
4. Read measured resistance on the display.

Tips for measuring resistance:

- Sometimes the resistor value and measured resistance differ. This is due to the meter's output test current goes through all possible paths between leads.
- For low resistance measurements, short the test leads and record the resistance displayed. Then connect to the circuit and subtract the recorded resistance from the measurement for the most accurate results.

 **WARNING**

**To avoid injury or damage to the meter, make sure to turn off all power and discharge all capacitors before measuring resistance.**

#### 4.6 Continuity

1. Turn off all power and discharge capacitors on the circuit under test.
2. Insert the red test lead in the "INPUT" jack and the black lead in the "COM" jack.
3. Move the rotary switch to the  position. Connect the test leads across the circuit to be measured.
4. Read measured resistance on the display. If the measured resistance is less than 50Ω, the meter's buzzer will sound.

 **WARNING**

**To avoid injury or damage to the meter, make sure to turn off all power and discharge all capacitors before measuring continuity.**

#### 4.7 Diode Test

1. Turn off all power and discharge capacitors on the circuit under test.
2. Insert the red test lead in the "INPUT" jack and the black lead in the "COM" jack.
3. Move the rotary switch to the  position. Connect the test leads across the circuit to be measured.
4. Read the measured forward biased voltage drop on the display. If the leads are reversed, only "1" is displayed.

 **WARNING**

**To avoid injury or damage to the meter, make sure to turn off all power and discharge all capacitors before measuring diodes.**

## 5. Specifications

### 5.1 General Specifications

- Safety rating: CAT III 600V, pollution degree 2
- Max. operating altitude: 2000m
- Operating temperature: 0~40°C, <80% RH
- Storage temperature: -10~60°C, <70% RH (battery removed)
- Temperature coefficient: 0.1 accuracy/°C (<18°C or >28°C)
- Max. voltage between terminals and ground: 600V DC or AC rms
- Sample rate: approx. 3 times/sec
- Display: 3 ½ digit LCD (max. display: 1999)
- Over-range indication: display only shows "1"
- Low battery indication: when battery voltage drops below operating voltage, "⎓" symbol appears on the display
- Polarity indication: automatically displays "-"
- Power: 3x 1.5V AAA batteries
- Dimensions: 198mmX79mmX38mm
- Weight: approx. 260g (with battery)
- Max. jaw opening: 26mm

## 5.2 Technical Specifications

Accuracy:  $\pm$ (% of reading + digits), 1 year warranty.  
 Ambient temp: 18°C~28°C, humidity: <75%.  
 Temperature coefficient: 0.1 accuracy/°C  
 (0°C~18°C or 28°C~40°C)

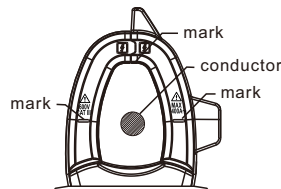

For AC current measurement, keep the conductor in the center of the clamp; otherwise the reading can deviate as much as 1.5% of actual measurement.

### 5.2.1 DC Voltage

Range	Resolution	Accuracy
600V	1V	$\pm$ (1.0% reading +3 dgt)

- Input impedance: 10M
- Overload protection: 600V DC or AC rms
- Max. input voltage: 600V DC

### 5.2.2 AC Voltage

Range	Resolution	Accuracy
600V	1V	$\pm$ (1.5% reading +10 dgt)

- Input impedance: 10M
- Overload protection: 600V DC or AC rms
- Max. input voltage: 600V AC rms
- Frequency range: 50Hz~60Hz
- Response: Average; calibrated to rms sine wave



## 5.2.3 AC Current

Range	Resolution	Accuracy
2A	0.001A	±(2.0% reading +10 dgt)
20A	0.01A	
400A	1A	±(2.0% reading +5 dgt)

- Frequency range: 50Hz~60Hz
- Max. input current: up to 120% of full scale for no more than 60 seconds.
- Response: Average; calibrated to rms sine wave.

## 5.2.4 Resistance

Range	Resolution	Accuracy
2kΩ	1Ω	±(1.0% reading +5 dgt)

- Open circuit voltage: approx. 2.0V
- Overload protection: 250V DC or AC rms

## 5.2.5 Diode Test

Range	Resolution	Function
	0.001V	Shows approx. forward biased voltage drop

- Forward DC current: approx. 1mA
- Reverse DC voltage: approx. 2.7V
- Overload protection: 250V DC or AC rms

## 5.2.6 Continuity

Range	Function
	If the measured resistance is less than 50Ω, the meter's buzzer will sound.

- Open circuit voltage: approx. 2.7V
- Overload protection: 250V DC or AC rms

## 6. Maintenance

### WARNING

Protection impairment if used in a manner not specified by the manufacturer.

### 6.1 General Maintenance

This section provides basic maintenance principles, including cleaning and battery replacement. Do not attempt to do any repair or calibration to the meter unless you are experienced maintenance personnel.

### WARNING

Remove test leads from meter before opening the battery cover to avoid damage or injury.

Use a damp cloth and a small amount of detergent to clean the meter regularly. Do not use abrasives or chemical solvents. Dirty or wet input jacks can affect readings.

To clean the input jacks:

1. Turn off meter and remove test leads.
2. Wipe any debris off input jacks.
3. Use a cotton swab with a cleaner/lubricant (i.e. WD-40) to clean jacks.
4. Use a new swab for each jack to prevent cross contamination.

## 6.2 Replacing the Batteries

### ⚠ WARNING

To avoid false reading that can lead to injury or damage to the meter, replace the battery as soon as the low battery symbol “” appears. Remove test leads and disconnect from all circuits before opening the battery cover.

To replace the batteries:

1. Power Supply: 3x 1.5V AAA batteries.
2. Turn off the meter and remove test leads.
3. Unscrew the battery cover.
4. Replace the used batteries with new ones. Be sure to observe polarity when replacing batteries.
5. Replace battery cover and tighten before use.

## 6.3 Replacing Test Leads

### ⚠ WARNING

When replacing test leads, only use similar leads or leads with same specs as those provided. Lead specs: 600V, 10A

### ⚠ WARNING

Use meet EN 61010-031 standard, rated CAT III 600V or better Test leads.

Replace test leads if leads become damaged or worn.

## 7. Accessories

1	User's manual	1 piece
2	Test leads	1 pair
3	Case	1 piece
4	AAA batteries (1.5V)	3 pieces

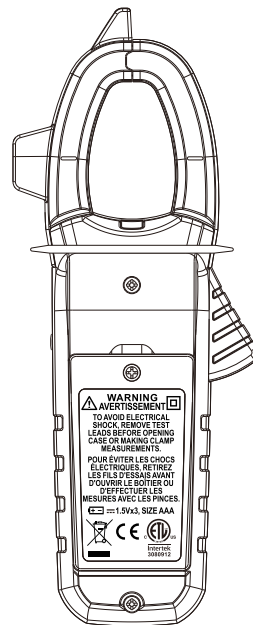

DONGGUAN HUAYI  
MASTECH COMPANY LIMITED  
Yuliangwei Industrial Area, Qingxi  
Dongguan, Guangdong, China  
<http://www.p-mastech.com>

