

MASTECH®

MY75

DIGITAL MULTIMETER OPERATION MANUAL

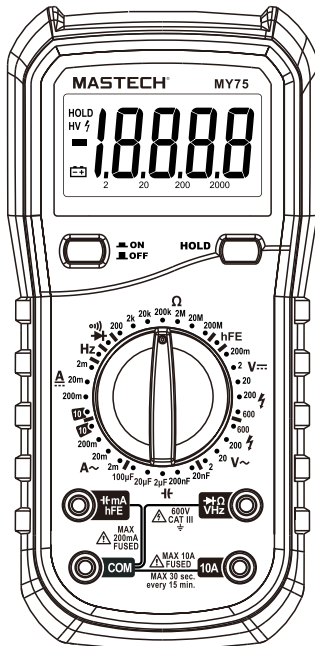

Intertek



MASTECH®

CONTENTS

General instructions	1
Safety instructions	1
Safe working habits	2
Safety symbols	4
Safety maintenance habits	5
Input protection measures	5
Meter appearance description	6
Meter appearance	5
Input socket	7
Display Description	7
Using the Meter	8
Preparation	8
DC/AC Voltage Measurement	9
DC/AC Current Measurement	10
Resistance Measurement	11
Diode	11
Continuity	12

MASTECH®

CONTENTS

Capacitance	12
Frequency Measurement	13
Transistor Gain	13
Specifications	14
General Specification	14
Technical Specifications	15
Maintenance	19
Replacing Batteries and fuse	19
Replacing test leads	19
Cleaning and Decontamination	20
Accessories	20

General instructions

The meter is designed and manufactured according to safety requirements of EN/UL/CSA 61010-1, 61010-2-030, 61010-2-033 on electronic measuring instrument and hand held digital multipurpose meter. The product meets with the requirements of 600V CAT III and pollution degree 2.

- All safety guidelines outlined should be followed, If the equipment is used in a manner not specified by the manufacturer, the protection provided by the equipment may be impaired.
- Warning symbols in the manual alert users of potential dangerous situations.
- Precautions are to prevent the user from damaging the instrument or the test object.

WARNING

The special attention should be paid when using the meter because the improper usage may cause electric shock and damage the meter. The safety measures in common safety regulations and operating instruction should be complied with when using. In order to make fully use of its functions and ensure safe operations please comply with the usage in this section carefully.

Safety instructions

- * When using this meter, the user should comply with the following standard safety procedures:
 - The safety procedures to prevent electric shock
 - The safety procedures to prevent wrong use
- * To ensure your safety, please use the test probe provided with the meter. Before use, please check and make sure that it is intact.









Safe working habits

- * If the meter is used near a source of significant electromagnetic interference, meter readings will become unstable and have large errors.
- * Don't use the meter or probe when it is broken.
- * If you do not use the meter in accordance with the instructions, safety functions provided by the meter may become invalid.
- * When you work around the bare conductor or bus bar, you should be extremely careful.
- * Do not use the meter near explosive gas, vapor or dust.
- * Measure known voltage with meter to verify that the meter is working properly. If the meter is working abnormally, do not use. Protective equipment may be damaged. If there is doubt, the meter should be sent to repair.
- * The meter should be used with correct input, function and measuring range.
- * When you can't determine the size range of signal to be tested, please switch the measuring range to the maximum position.
- * Input value can't exceed the input limit specified in each measuring range to prevent damage to the meter.
- * When the meter is connected to the circuit being measured, do not touch the unused input end.
- * When the voltage to be tested exceeds 60Vdc or 30Vac effective value, please operate carefully to prevent electric shock.
- * When you measure with test probe, first connect the common testing end of black test probe to the common testing end of circuit to be tested, then connect red test leads to the test circuit of the test probe to the test end of circuit to be tested. When the measurement is completed, you should first remove the red test probe, then remove the black common test probe.

- * When use the test probe to measure, you should place your fingers at the back of retaining ring.
- * Before changing the measuring range, you must ensure that the test probe is not connected to circuit to be tested.
- * For all DC functions, including manual or automatic measuring range, to avoid the risk of electric shock due to possible incorrect readings, please use AC function to verify the existence of any AC voltage. Then, select DC voltage measuring range equal to or greater than the AC measuring range.
- * Before testing resistance, diode, capacitance measurement or on-off states, you should first cut off power to the circuit being tested, and discharge all high voltage capacitors.
- * Don't measure resistance or make on-off tests on a live circuit.
- * Before current measurement, you should firstly check the meter's fuse. Before the meter is connected to the circuit under testing, you should firstly power off the circuit to be tested.
- * When you make TV repairs or measure power conversion circuits, you should note the high amplitude voltage pulse of circuits being tested. The TV filter should be used to weaken these pulses to avoid the meter damage.
- * This meter uses a 9V 6F22 battery. The battery should be properly installed in the meter's battery compartment.
- * When the battery indicator  appears, the battery should be replaced immediately. Low battery will cause meter reading errors, and possibly result in electric shock or personal injury
- * When you make type III voltage measurement, the voltage should not exceed 600V; when you make type TV voltage measurement, the voltage should not exceed 600V.
- * When the meter shell (or part of shell) is removed, do not use the meter.

1.1.3 Safety symbols

Symbols used on the meter surface and instructions:

	Note-Important safety information, refer to the instruction manual.
	Caution, possibility of electric shock
	Equipment protected throughout by double insulation or reinforced insulation.
	Conforms to UL STD. 61010-1, 61010-2-030, 61010-2-033; Certified to CSA STD. C22.2 NO. 61010-1, 61010-2-030, 61010-2-033
	Complies with European (EU) safety standards
	Earth (ground) TERMINAL
	Direct current
	Alternating current
CAT III	MEASUREMENT CATEGORY III is applicable to test and measuring circuits connected to the distribution part of the building's low-voltage MAINS installation.

Safe maintenance habits

- * To open the meter shell or remove the battery cover, you should first pull out the test probe.
- * When performing meter maintenance, you should use specified replacement parts.
- * Before opening the meter, you should disconnect all power supplies and ensure that you have no static electricity to avoid damaging the meter components.
- * Meter calibration, maintenance, repair and other operations only can be performed by technicians who fully understand the meter and electrical shock hazards.
- * Before opening the meter, you should be aware that there may be dangerous voltages remaining in some capacitances in the meter even after powering off.
- * If you find any abnormal phenomena on the meter, the meter should be immediately turned off and repaired. Ensure that it can not be used before passing inspection.
- * When the meter is not used for a long time, please remove the battery and avoid storing it in a high temperature and humidity environment.

Input protection measures

- * When making voltage measurements (not including 200mV grade), the maximum input voltage is 600V DC or 600V AC. (The maximum input voltage of 200mV grade is 250V AC or equivalent RMS value voltage).
- * When making frequency, resistance, on-off and diode measurements, the maximum voltage is 250V AC or equivalent RMS value voltage.
- * When making capacitance, temperature, mA current, and triode hFE measurements, the meter is protected through a fuse (FF 400mA H 600V).

Meter appearance description

Meter appearance

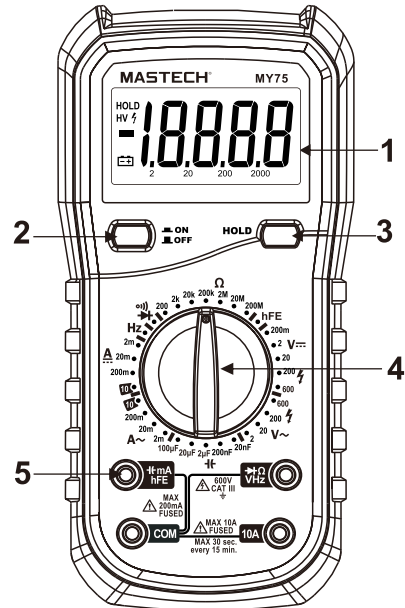



1. **Display:** 4 1/2 digit, (20000 count) LCD.
2. **Power Button**
3. **Hold Button:** to hold the last reading.
4. **Rotary switch:** to select functions and desired ranges.
5. **Input Sockets**

Input Socket

Input Socket	Description
COM	All common input ends to be measured are connected with common output socket of black test probe or dedicated multifunction test socket.
 V,Ω,Hz	Positive input end of voltage, resistance, frequency, diode, buzzer measurement (connected with the red test probe).
mA, hF hFE	Positive input end of current mA, capacitance and triode hFE (connected with output socket of black test probe or dedicated multifunction test socket).
10A	Positive input end of 10A (connected with the red test probe).

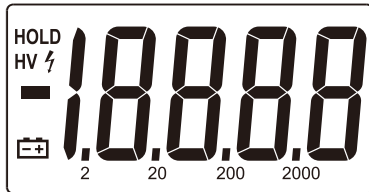

Display Description



Symbols	Indication
	Low battery. To avoid wrong readings causing electric shock or personal injury, when the low battery symbol appears, the battery should be replaced immediately.
	Negative input polarity indication
HOLD	Keep the current measurement value

Using the Meter

Preparation

- Switch on the power by turning the rotary switch. If the battery voltage is lower than 7V, the  symbol will appear and the batteries should be replaced.
- The  symbol next to the input lead shows that the input voltage or current should not exceed the specified value in order to protect the internal circuit from damage.
- Turn the rotary switch to the required function and range to be measured.
- Choose the highest range when the value to be measured is unknown.
- When making connection, connect the common test lead first and then the powered test lead.
- Removed the charged test lead first when disconnecting.

Readings Hold

- Press “HOLD” button to hold the readings of current measurement.
- Press “HOLD” button again to release the hold.

DC/AC Voltage Measurement

WARNING:

To prevent electrical shock and/or meter damage, Don't measure any RMS voltage higher than 600V DC or 600V AC between common end and ground.

- Plug the black test lead into the “**COM**” jack and the red test lead into the “**VΩ↔Hz**” jack.
- Set the rotary switch to the “**V**” position for DC measurement and “**V~**” for AC measurement and at the proper range.
- Connect the test leads to the voltage source or load for measurement.
- Read the value on the main indicator of the LCD. The polarity symbol denotes the polarity of the end connected by the red test lead.

NOTE:

- At small voltage ranges, unsteady readings will appear before the test leads make contact with the circuit. This is normal since the Meter is highly sensitive. When the test leads are connected to the circuit, the true reading will be shown.
- When “1” is shown on the LCD, it means the measurement has exceeded the allowable range. A higher range should be selected.
- When the scale of the value to be measured is unknown, select the highest range first and lower the range accordingly.

DC/AC Current Measurement

WARNING:

To prevent electrical shock and/or meter damage, power off the circuit and discharge the capacitance before measuring current.

- Plug the black test lead into the “**COM**” jack.
- When the current to be measured is under 200mA, plug the red test lead into the “**mA**” jack; when the current to be measured is over 200mA but under 10A, plug the red test lead into the “**10A**” jack.
- Set the rotary switch to the “**A**” position for DC measurement and “**A~**” for AC measurement and at the proper range.
- Connect the test leads to the circuit.
- Read the value on the display.
- The polarity symbol denotes the polarity of the red test lead.

NOTE:

- When '1' is shown on the LCD, it means the measurement has exceeded the allowable range; a higher range should be selected.
- When the scale of the value to be measured is unknown, select the highest range first and then lower the range accordingly.
- “

10

Resistance Measurement

WARNING:

To avoid damaging meter or device to be measured, before measuring resistance, cut off all circuits being tested and discharge all high voltage capacitors.

- Plug the black test lead into the “**COM**” jack and the red test lead into the “**VΩ → Hz**” jack.
- Set the rotary switch to the “**Ω**” position and at the proper range.
- Connect the test leads to the ends of the resistor or circuit.
- Read the value on the LCD.

NOTE:

When the input is open, “1” is displayed on the LCD to indicate overload. For measuring resistance above 1MΩ, it may take a few seconds to get a steady reading. This is normal for high resistance measurement.

Diode

- Plug the black test lead into the “**COM**” jack and the red test lead into the “**VΩ → Hz**” jack.
- Set the rotary switch to the “**→|**” position
- Connect the red test lead to the anode and the black test lead to the cathode of the diode for testing.
- Read the value on the LCD.

NOTE:

- The meter will show approximate forward voltage drop of the diode.
- When the test leads are reversed or opened, ‘1’ will appear on the LCD.

Continuity

WARNING:

To avoid damaging meter or device to be measured, before testing buzzer continuity, cut off all circuits being tested and discharge all high voltage capacitors.

- Plug the black test lead into the “**COM**” jack and the red test lead into the “**VΩ → Hz**” jack.
- Set the rotary switch to the “**→|)**” position.
- Connect the test leads to two ends of the circuit. If resistance of the circuit is less than 60Ω the built-in buzzer will sound.

Capacitance

WARNING:

To avoid damaging meter or device to be measured, before measuring capacitance, cut off all circuits being tested and discharge all high voltage capacitors. Determine that capacitors are discharged with DC voltage measurement function.

- Plug the black test lead into the “**COM**” jack and the red test lead into the “**hFE → mA**” jack.
- Set the rotary switch to the “**→|**” position and at the proper range.
- Connect the test leads to two ends of the circuit/capacitor and read the value on the LCD.

Frequency Measurement

- Plug the black test lead into the “COM” jack and the red test lead into the “VΩ Hz” jack.
- Set the rotary switch to the “Hz” position.
- Connect test leads to the two ends of the circuit for measurement.
- Read the value on the LCD.

Transistor Gain

WARNING:

To prevent electrical shock and/or meter damage, don't apply any RMS voltage higher than 250V DC or AC between common end and mA end.

- Plug the multi-function socket with the “IN” end in the “hFE mA” jack and the “COM” end in the “COM” jack.
- Set the rotary switch to the “hFE” position and at the proper range.
- Determine if the transistor to be tested is either an NPN or PNP type, then insert the three pins of the transistor into the corresponding holes of the multi-function socket.
- Read the approximate transistor gain on the LCD.

Specifications

General Specification

- Overload protection is provided for all modes (CAT III 600V, pollution grade 2).
- Maximum voltage between terminals and earth ground: 600V DC/600V AC
- Display: LCD
- Maximum value display: 1999
- Polarity indication: automatic; “-” for negative polarity.
- Overload indication: “1”
- Auto power off time: 20min
- Resettable fuse: F1 FF 400mA H 600V
- Fuse protection: F2 FF 10A H 600V
- Power supply: DC 9V from battery
- Battery type: NEDA 1604, 6F22 or 006P.
- Battery low indication: “” on LCD
- Operating Temperature: 0°C to 40°C (32°F to 104°F)
- Storage Temperature: 0°C to 60°C (32°F to 140°F)
- Dimension: 188×93×50mm (7.4×3.7×1.9in.)
- Weight: approximate 380g (13oz) including battery

Technical Specifications

DC Voltage

Range	Resolution	Accuracy
200mV	0.01mV	±(0.05% of reading + 3digits)
2V	0.1mV	±(0.1% of reading + 3digits)
20V	1mV	
200V	10mV	
600V	0.1V	±(0.15% of reading + 3digits)

- Max input voltage: 250V DC at 200mV range, 600V DC elsewhere.
- Input impedance: 10MΩ

NOTE:

- At small voltage ranges, unsteady readings will appear before the test leads make contact with the circuit. This is normal since the meter is highly sensitive. When the test leads connect to the circuit, the true reading will be shown.

AC Voltage

Range	Resolution	Accuracy
2V	0.1mV	±(0.5% of reading +3digits)
20V	1mV	±(0.8% of reading +10digits)
200V	10mV	
600V	0.1V	±(1.0% of reading +15 digits)

- Max input voltage: 250V AC at 200mV range, 600V AC elsewhere.
- Input impedance: 10MΩ
- Frequency response: 200Hz at 600V range, 40-400Hzelsewhere
- Response: Average (RMS of sine wave)

NOTE:

- At small voltage ranges, unsteady readings will appear before the test leads make contact with the circuit. This is normal since the meter is highly sensitive. When the test leads connect to the circuit, the true reading will be shown.

DC Current

Range	Resolution	Accuracy
2mA	0.1 A	±(0.5% of reading + 50digits)
20mA	1μA	
200mA	10μA	±(0.8% of reading + 50digits)
10A	1mA	±(2.0% of reading + 10digits)

- Overload protection:
mA ranges: F1, FF 400mA H 600V
10A range: F2, FF 10A H 600V
- Max input current:
mA jack (mA range): 200 mA
10A jack: 10A
10A grade: 10A DC or AC RMS

When measured current is greater than 10A, continuous measurement time should not be more than 10 seconds. Stop the current being measured after 15 minutes.

AC Current

Range	Resolution	Accuracy
2mA	0.1 A	±(0.8% of reading + 50digits)
20mA	1µA	
200mA	10µA	±(1.2% of reading + 50digits)
10A	1mA	±(2.5% of reading + 10digits)

- Overload protection:
mA ranges: F1, FF 400mA H 600V
10A range: F2, FF 10A H 600V
- Max input current:
mA jack (mA range): 200 mA ; 10A jack: 10A.
10A grade: 10A DC or AC RMS

When measured current is greater than 10A, continuous measurement time should not be more than 10 seconds. Stop the current being measured after 15 minutes.

- Frequency response: 40-400Hz
- Response: Average (RMS of sine wave)

Resistance

Range	Resolution	Accuracy
200	0.01	±(0.5% of reading + 10digits)
2k	0.1	±(0.3% of reading + 3digits)
20k	1	±(0.3% of reading + 1digits)
200k	10	
2M	100	
20M	1k	
200M	10k	

- Overload protection: 250V DC/AC
- Open circuit voltage: DC ≈ 2.8V

Diode Test

	Resolution	Function
	0.1mA	Displaying approximate forward voltage of diode

Continuity Test

	Function
	Built-in buzzer will sound if resistance is lower than 60Ω.

Frequency

Range	Resolution	Accuracy
20kHz	1Hz	±(1.5% of reading + 5 digits)

Capacitance

Range	Resolution	Accuracy
20nF	0.1nF	±(4.0% of reading + 20 digits)
200nF	1nF	
2µF	10nF	
20µF	1pF	
100µF	10pF	

Transistor

Range	Description	Test Condition
hFE	hFE approximation (0-1000)	Base current 10µA Vce is about DC 2.8V

Maintenance

Replacing Battery and Fuse

⚠ WARNING:

To avoid electrical shock or personal injury, before opening the battery cover to replace battery, you should turn the meter off and make sure that the test probe is disconnected from the measurement circuit.

To avoid wrong readings, electric shock or personal injury, when “” appears on the meter display, replace the battery immediately.

Use only a fuse with specified amperage, fusing rated value, voltage rated value and fusing speed (F1: FF 400mA H 600V, F2: FF 10A H 600V)

Please follow below steps to replace battery or fuse:

1. Turn off the power supply of the meter.
2. Pull out all test probes from the input socket.
3. Loosen two screws on the fixed battery cover with screwdriver.
4. Remove the battery cover.
5. Remove the old battery or damaged fuse.
6. Replace with a new battery with 9V (6F22) or a new fuse.
7. Replace the battery cover and tighten the screws.

Replacing Test Leads

If insulation on leads is damaged, replace it.

⚠ WARNING:

Use meet EN 61010-031 standard, rated CAT III 600V, 10A or better test leads.

Cleaning and Decontamination

- The meter can be cleaned with a soft cloth to remove any oil, grease or grime.
- Do not use liquid solvent or detergent.

Accessories

- Test Leads 1set
- Package 1pcs
- 9V Battery 1pcs
- User's Manual 1pcs



00-05-4178