

MASTECH[®] MS8360F

DIGITAL MULTIMETER USER MANUAL

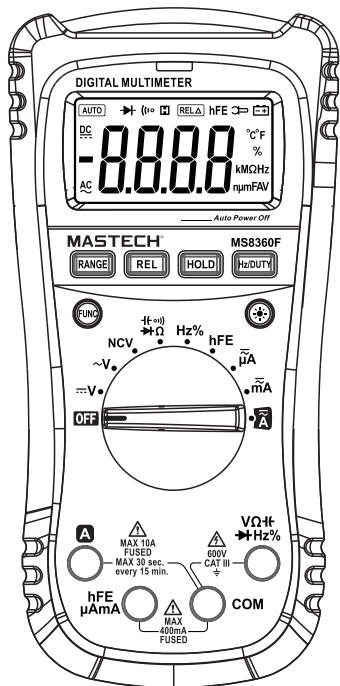

CAT III
600V

CE

CONTENTS

1. Introduction	1
2.Safety Information	1
3.Product Description	2
3.1 Appearance Description	2
3.2. Function.....	4
3.3.Electrical symbols.....	5
4. Technical Index	5
4.1 General Features	5
4.2 Electrical technical index.....	6
5. Measurement Operations.....	9
5.1 Measurement of DC and AC voltages	9
5.2 Resistance measurement.....	10
5.3 Diode test.....	11
5.4 Buzzer continuity test	12
5.5 Capacitance measurement.....	12
5.6 Transistor measurement.....	13
5.7 Frequency measurement.....	14
5.8 Current measurement.....	15
5.9 Non-contact voltage detection.....	16
6.Maintenance	17
6.1 Replacement of batteries.....	17
6.2 Replacement of fuse.....	17
6.3. Cleaning.....	18

1. Introduction

This digital multimeter has been designed and manufactured in accordance with the safety requirements of the IEC-61010 standard for electronic measuring instruments and handheld digital multimeters, and complies with the 600V CAT III and pollution degree 2 requirements in IEC61010-1.

This meter can be used to measure DC voltage, AC voltage, resistance, diode, buzzer, capacitance, frequency, transistor, DC current, AC current and duty cycle, and to perform continuity test, etc. The exclusive non-contact voltage detection function can remind you timely of operating safely. The full-range AC220V protection design provides safer and more reassuring operation. This series of meters can be applied widely to schools, laboratories, research institutes, electronic enterprises and plants.

Please read this manual carefully before operating this meter and observe the appropriate safety precautions strictly.

2. Safety Information



This meter should be operated with extreme care. Improper operation may result in the risk of electric shock or damage this meter. Please observe the customary safety rules and the safety measures specified in this manual completely.

In order to avoid any personal injury or damage to this meter arising from electric shock, the user should pay attention to the following safety precautions:

1. Do not measure any voltage beyond the specified measuring range of this meter;
2. Do not apply any high voltage (>100V) on the input terminal of a resistor or diode being measured despite of the internal protection circuit.
3. Check the test cable for damage or exposure of the metallic part.
4. Do not use this meter in areas exposed to direct sunlight or high temperatures.
5. Pay attention to the possibility of electric shock when measuring any voltage of over 36V AC or 48V DC.
6. Before current measurement, turn off the power of the unit under test, disconnect the circuit under test, connect the test probes and then energize the unit under test.
7. Pay attention to polarity when replacing the batteries.



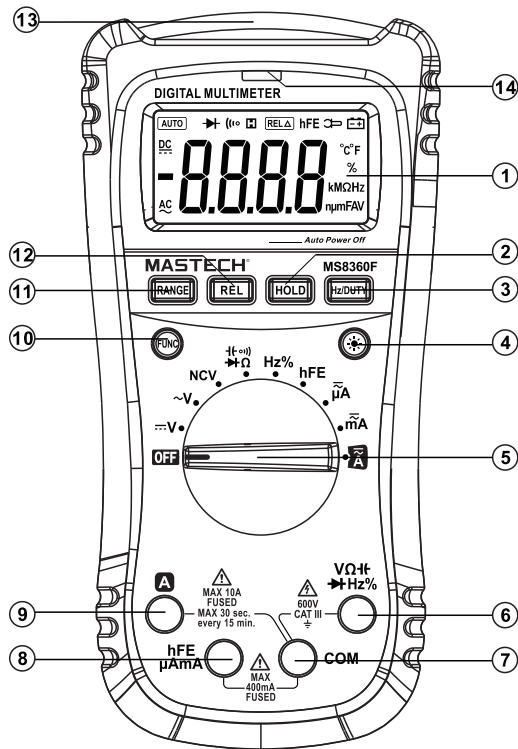

3. Product Description



3.1. Appearance Description









1. LCD (liquid crystal display)
2. Data holding (HOLD)
3. Frequency/duty cycle measurement
4. Background light switch
5. Knob
6. Voltage, resistance, frequency, diode and capacitance input terminal
7. Common terminal
8. Current and transistor input terminal
9. High_current input terminal
10. Function selector
11. Manual range selector key
12. Relative value measurement key
13. Non-contact voltage detection area
14. Non-contact voltage detection indicator light

3.2. Function keys

	Function changeover key: current range selection, DC/AC mode, diode range changeover, diode test mode and continuity test mode.
	Holding key: When this key is pressed during measurement, the current reading of The meter will be locked on the LCD. Press it again to release the holding state.
	Manual/auto range selector key: The range will change when this key is pressed. Hold on to it (for about 2 sec) to switch to the auto range.
	Backlit function keys, Click button once, backlight lamp lit, about 15 seconds after shut down automatically.

	Frequency, duty cycle options in the voltage, frequency, current mode and Effective.
	Relative value measurement functions, in addition to "HZ/Duty" functions, can be done.

3.3. Electrical symbols :

	Dangerous voltage
	Ground
	AC Mode
	DC Mode
	Double insulation
	Fuse
	Warning! See the appropriate instructions.

4. Technical Index

4-1. General Features

- Manual range DMM, max. 3999
- Display: 3 3/4-digit LCD display
- Overload protection: full range protection
- Data holding function
- Relative value measurement
- Backlight
- Low-voltage display
- Auto power off
- Operating temperature and humidity: 0-40°C(32-104 °F); relative humidity < 80% RH

- Storage temperature and humidity: -10-50°C(14-122 °F); relative humidity <70%RH
- Power supply: 6F22 9V batteries
- Safety rating: IEC61010-1, CAT III 600V.
- Dimensions: (L x W x H) 92 X 188 X 50 mm, weight: approx. 350 g

4.2. Electrical technical index

(Ambient temperature: 23 ± 5°C; relative humidity: <75%)

4.2.1 DC Voltage

Range	Resolution	Accuracy
400mV	0.1mV	±(0.5% of rdg +2 digit)
4V	1mV	
40V	10mV	
400V	100mV	
600V	1V	±(0.8% of rdg +5 digit)

Input impedance:10MΩ Max. input voltage:600V DC
Overload protection: 600V DC or AC RMS

4.2.2 AC Voltage

Range	Resolution	Accuracy
400mV	0.1mV	±(1.2% of rdg +20 digit)
4V	1mV	±(0.8% of rdg +3 digit)
40V	10mV	
400V	100mV	
600V	1V	±(1.0% of rdg +5 digit)

Input impedance:10MΩ Max. input voltage:600V DC
Overload protection: 600V DC or AC RMS
Frequency range: 40-400Hz
Response: average (rms of sine wave)



4.2.3 Resistance

Range	Resolution	Accuracy
400Ω	0.1Ω	±(1.0% of rdg +3 digit)
4kΩ	1Ω	
40kΩ	10Ω	
400kΩ	100Ω	
4MΩ	1kΩ	±(1.2% of rdg +15 digit)
40MΩ	10kΩ	

Open circuit voltage: approx. 0.45V

Overload protection: 250VDC or AC rms

4.2.4 Diode and circuit continuity

Range	Function
	Displaying the forward voltage drop of the diode
	When the resistance is less than (50±20)Ω, the buzzer will beep

Open circuit voltage: approx. 0.5V

Overload protection: 250VDC or AC rms

4.2.5 DC current

Range	Resolution	Accuracy
400μA	0.1μA	±(0.8% of rdg +2 digit)
4mA	1μA	
40mA	10μA	
400mA	100μA	
10A	10mA	±(1.2% of rdg +2 digit)

Max. current: mA jack: 400mA, A jack:10A

Overload protection: mA range: FF400mA/1KV Fuse
10A range: FF10A/600V Fuse

4.2.6 AC Current

Range	Resolution	Accuracy
400μA	0.1μA	±(1.0% of rdg +8 digit)
4mA	1μA	
40mA	10μA	
400mA	100μA	
10A	10mA	±(2.0% of rdg +10 digit)

Max. current: mA jack: 400mA, A jack:10A
 Overload protection: mA range: FF400mA/1KV Fuse
 10A range: FF10A/600V Fuse
 Frequency range: 40-400Hz
 Response: Average (rms of sine wave)

4.2.7 Transistor hFE

Range	Function
hFE	Displaying the approximate hFE value: 1-1,000 times

Base current: approx. 1 mA, Vce: approx. 2.5V
 Protection: FF400mA/ 1KV quick-acting fuse

4.2.8 Capacitance

Range	Resolution	Accuracy
5nF	1pF	±(4.0% of rdg +15 digit)
50nF	10pF	
500nF	100pF	
5μF	1nF	
50μF	10nF	
200μF	100nF	

Overload protection: FF400mA/ 1KV quick-acting fuse
 36VDC or AC rms

4.2.9 Frequency

Range	Resolution	Accuracy
9.999Hz	0.001Hz	±(4.0% of rdg +15 digit)
99.99Hz	0.01Hz	
999.9Hz	0.1Hz	
9.999kHz	0.001kHz	
99.99kHz	0.01kHz	
999.9kHz	0.1kHz	
9.999MHz	0.001MHz	

Overload protection: 250VDC or AC rms
 Measuring range: 1 V-10V rms

5. Measurement Operations

5.1 Measurement of DC and AC voltages



Warning

1. Do not measure any voltage of over 600V DC or 600V AC rms for fear of electric shock or damaging the meter.
2. Do not apply any voltage of over 600V DC or 600V AC rms between the meter and the ground for fear of electric shock or damaging the meter.

Voltage range of this meter:

DC voltage: 400.0mV, 4.000V, 40.00V, 400.0V and 600V
AC voltage: 400.0mV, 4.000V, 40.00V, 400.0V and 600V

Procedures of voltage measurement:

1. Turn the range selector to the V range.
 2. Connect the black and red probes to the COM input jack and the V input jack.
 3. Measure the voltage of the circuit under test with the other two terminals of the test probes (connected in parallel with the circuit under test).
 4. Read the measured voltage value on the LCD.
- During DC voltage measurement, the LCD will also display the polarity of the voltage connected by the red probe.

Note:

If there is no input in the 200mV DC or 2V AC range, the meter would display a reading of several digits due to external interference, but the normal operation and measuring accuracy of the meter will not be affected.

5.2 Resistance measurement



Warning

To protect the meter and the unit under test from damage, all power supplies of the circuit under test should be cut off and all high-voltage capacitors should be discharged before resistance measurement. Resistance range of this meter: 400. 0 Ω , 4. 000k Ω , 40. 00k Ω , 400. 0k Ω , 4. 000M Ω , 40. 00M Ω

Procedures of resistance measurement:

1. Turn the range selector to the $\text{M}\Omega$ range and press the FUNK key to select the Ω range.
2. Connect the black and red probes to the COM input jack and the V input jack.
3. Measure the resistance of the circuit under test with the other two terminals of the test probes.
4. Read the measured resistance value on the LCD.

Note:

1. The resistance measured on line may differ from the resistance rating. This is because the connection between any other component on the circuit and the resistor under test may be equivalent to the connection of two or more resistors in parallel.
2. In case of low resistance measurement, please short-circuit the test probes for the sake of accuracy, and read the resistance value displayed when the test probes are in the short circuit state, minus the measured value of the resistor under test.
3. In the high-resistance range, the reading will remain unstable until several seconds later.
4. In the open circuit state, the meter will display "OL", indicating that the measured value exceeds the range.

5.3 Diode test



Warning

To protect the meter and the unit under test from damage, all power supplies of the circuit under test should be cut off and all high-voltage capacitors should be discharged before the diode test.

Procedures of diode test:

1. Turn the range selector to the $\text{M}\Omega$ range and press the FUNK key to select the D range.
2. Connect the black and red probes to the COM input jack and the V input jack.
3. Connect the black and red probes to the positive and negative electrodes of the diode under test respectively.
4. The meter will display the forward bias voltage of the diode under test. If the polarity of the test probes is reversed, the meter will display "OL".

Note:

In case of forward on-line diode measurement, the forward voltage drop will be displayed; the reverse measurement depends on the value of any other component connected in parallel between both terminals of the diode.

5.4 Buzzer continuity test



Warning

To protect the meter and the unit under test from damage, all power supplies of the circuit under test should be cut off and all high-voltage capacitors should be discharged before the continuity test.

Procedures of continuity test:

Turn the range selector to the $\rightarrow \Omega$ range and press the FUNC key to select the $\rightarrow \Omega$ range.

1. Connect the black and red probes to the COM input jack and the V input jack.
2. Connect both terminals of the test probes to the circuit of the unit under test.
3. The meter will display the approximate resistance between the two points under test. At this point, if the resistance between the two points under test is less than $(70 \pm 20) \Omega$, the buzzer will beep.

5.5 Capacitance measurement



Warning

To protect the meter and the unit under test from damage, all power supplies of the circuit under test should be cut off and all high-voltage capacitors should be discharged before capacitance measurement.

Capacitance range of this meter:

5.000nF, 50.00nF, 500.0nF, 5.000 μ F, 50.00 μ F, 200 μ F

Procedures of capacitance measurement:

1. Turn the range selector to the $\rightarrow \Omega$ range and press the FUNC key to select the $\rightarrow \Omega$ range.
2. Connect the black and red probes to the COM input jack and the V input jack. (You may also use the special multifunctional test socket to measure capacitance.)
3. Measure the two pins of the capacitor under test with the other two terminals of the test probes and read the measured value on the LCD.

Note:

1. When the meter is measuring a high capacitance, the reading will take some time to get stabilized.
2. When the meter is measuring a low capacitance of less than 10nF, the distributed capacitance of the meter and the wire should be subtracted (i.e., the displayed base number).

5.6 Transistor measurement



Warning

Do not apply any voltage of over 36V DC or AC rms on the common terminal and the hFE terminal for fear of electric shock and/or damaging the meter.

Procedures of transistor measurement:

1. Turn the range selector to the hFE range.
2. Connect the special multifunctional test socket in the proper polarity (connect the "+" plug of the special multifunctional test socket to the hFE terminal and the "COM" plug to the common terminal).

3. Judge if the transistor is the NPN or PNP type, then plug thee, b and c probes of the transistor into the corresponding jacks of the special multifunctional test socket.
4. Read the approximate hFE value of the transistor under test on the LCD.

5.7 Frequency measurement



Warning

Do not measure the frequency of any voltage of over 250V DC or AC rms for fear of electric shock or damaging the meter.

Procedures of frequency measurement:

1. Turn the range selector to the Hz range.
2. Connect the black and red probes to the COM input jack and the Hz input jack.
3. Measure the frequency of the circuit under test with the other two terminals of the test probes.
4. Read the measured frequency value on the LCD.

Note:

Do not input a voltage of over 10V rms. Though the meter may measure such voltage, the accuracy of reading is not guaranteed.

5.8 Current measurement



Warning

To protect the meter and the unit under test from damage, check the fuse of the meter before current measurement.

Use the right input jack, function and range during measurement.

When the open circuit voltage is over 250V, do not attempt to make any current measurement on the circuit. When a test probe is plugged into the current input jack, do not cross the other end of the test probe over to any circuit in parallel.

The DC current range is:400μA, 4.000mA, 40.00mA, 400.0mA and 10.00A.

The AC current range is:400μA, 4.000mA, 40.00mA, 400.0mA and 10.00A

Procedures of current measurement:

1. Cut off the power supply of the circuit under test and discharge all high-voltage capacitors on the circuit under test.
2. Turn the range selector to an appropriate range.
3. Connect the black probe to the COM input jack. If the current to be measured is less than 400mA, connect the red probe to the mA input jack; if the current to be measured is within 400mA-10A, connect the red probe to the 10A input jack.
4. Disconnect the circuit under test. Connect the black probe to one terminal (with a lower voltage) of the disconnected circuit, and the red probe to the other one terminal (with a higher voltage) of the disconnected circuit.

5. Connect the power supply of the circuit and read the displayed reading. If the LCD displays “OL” only, the input exceeds the selected range and the range selector should be set to a higher range.
6. Disconnect the power supply of the circuit under test, discharge all capacitors, remove the test probes of the meter and restore the circuit to the original condition.

Note:

1. The meter should be connected in series other than in parallel for current measurement for fear of damaging the meter or endangering personal safety.
2. In case of prolonged measurement in the high current range (10A), the display accuracy of the meter will be affected (the standard test time is not more than 10seconds at a time, with an interval of at least 3 minutes).
3. During DC current measurement, if the test probes are connected reversely to the circuit, the displayed value will become negative, but the measuring accuracy of the meter will not be affected.

5.9 Non-contact voltage detection



Warning

Under different external interference sources, there might be a false alarm.

The measured value is for reference only. Turn the meter to the $\overset{NCV}{\sim}V$ range. When the circuit under test is close to the neck of the meter, the voltage induction indicator light of the meter will be turned on, and the buzzer will give the alarm tone of “beep-beep-beep”.

Note:

1. A voltage may still be present even if there is no indication. Do not rely on the non-contact voltage detection function to judge whether a voltage is present on a wire.
2. The detection operation may be affected by such factors as jack design, insulation thickness and type of the wire.
3. When an input voltage is applied on the input terminal of the meter, the voltage induction indicator light may also be turned on due to the presence of an induced voltage.
4. External interference sources (flashlight, motor, etc.) may lead to misjudgment.
5. Connect the black and red probes to the COM input jack and the V input jack before taking a reading.

6. Maintenance

6.1. Replacement of batteries

When the  symbol appears on the LCD during the operation of the meter, the batteries must be replaced, otherwise the meter may operate improperly.

Procedures of battery replacement:

1. Remove the test cable and turn off the power.
2. Open the battery cover on the rear case with a screwdriver and remove the batteries.
3. Load batteries of the same specification and fasten the battery cover.

6.2. Replacement of fuse

Procedures of fuse replacement:

1. Remove the test cable and shut down the meter.
2. Open the battery cover on the rear case with a screwdriver and remove the damaged fuse.
3. Load a fuse of the same specification, put on the battery cover and fasten the screws.

6.3. Cleaning

When it is necessary to clean the surface of the meter, please use a soft cloth other than any organic solvent that may corrode or dissolve the casing.

