

MASTECH®

MS8233E

Digital Multimeter

Instruction Manual

for

MS8233A MS8233B MS8233C MS8233E

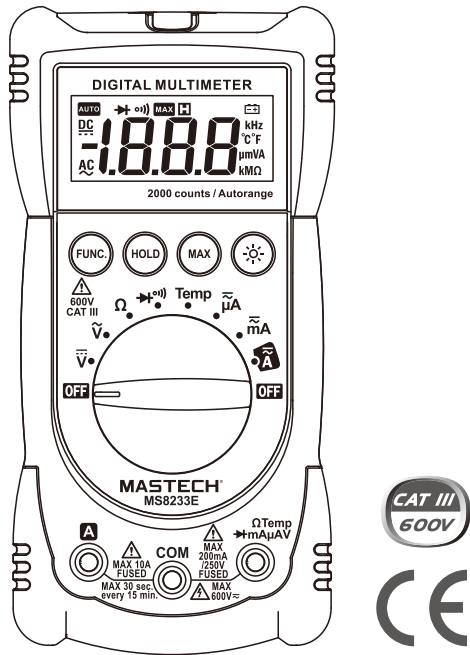

CONTENTS

1. SAFETY INFORMATION.....	3
1.1 Safety symbols	3
1.2 Maintenance.....	3
1.3 During use	4
2. SPECIFICATIONS	5
2.1 Features	6
3. FRONT PANEL	7
3.1 Front panel description.....	8
3.2 General.....	9





CONTENTS

4. OPERATING INSTRUCTIONS	10
4.1 DC/AC voltage measurement	10
4.2 DC/AC current measurement.....	10
4.3 Resistance measurement	11
4.4 Diode test	11
4.5 Audible continuity test.....	11
4.6 Measuring temperature.....	12
4.7 Non-contact voltage detection	12
5. BATTERY & FUSE REPLACEMENT	13
5.1 Accessories.....	13

1. SAFETY INFORMATION

This multimeter has been designed according to IEC61010-1 concerning electronic measuring instruments with an overvoltage category (CAT III) and pollution 2. Follow all safety and operating instructions to ensure that the meter is used safely and is kept in good operating condition. Full compliance with safety standards can be guaranteed only with test leads supplied. If necessary, they must be replaced with the type specified in this manual.

1.1 Safety symbols

	Important safety information, refer to the operating manual.
	Dangerous voltage may be present
	Anti-garbage
	Double insulation (Protection class II).
	Fuse must be replaced with rating specified in the manual.

1.2 Maintenance

- Before opening the case, always disconnect test leads from all energized circuits.
- For continue protection against fire; replace fuse only with the specified voltage and current ratings:
F1: FF 400mA H 600V
F2: FF 10A H 600V
- Never use the meter unless the back cover is in place and fastened completely.
- Do not use abrasives or solvents on the meter. To clean it using a damp cloth and mild detergent only

1.3 During use

- Never exceed the protection limit values indicated in specifications for each range of measurement.
- When the meter is linked to measurement circuit, do not touch unused terminals.
- Never use the meter to measure voltages that might exceed 600V above earth ground in category III installations.
- When the value scale to be measured is unknown beforehand, set the range selector at the highest position.
- Before rotating the range selector to change functions, disconnect test leads from the circuit under test.
- When carrying out measurements on TV or switching power circuits always remember that there may be high amplitude voltages pulses at test points, which can damage the meter.
- Always is careful when working with voltages above 60V dc or 30V ac rms. Keep fingers behind the probe barriers when making voltage measurements with test leads.
- Never perform resistance measurements on live circuits

2. SPECIFICATIONS

Accuracy is specified for a period of one year after calibration and at 18°C to 28°C (64°F to 82°F) with relative humidity to 80%.

Spec	Features	Accuracy			
		MS 8233A	MS 8233B	MS 8233C	MS 8233E
DC Voltage	200mV/2V/ 20V/200V/ 600V				±(0.5%+2)
	200mV/2V/ 20V/200V	±(0.5%+3)	±(0.5%+3)	±(0.5%+3)	
	600V	±(0.5%+3)	±(0.5%+3)	±(0.5%+3)	±(0.8%+2)
AC Voltage	2V/20V/ 200V/600V				±(1.2%+10)
	200V/600V	±(1.2%+10)	±(1.2%+10)	±(1.2%+10)	
DC Current	200µA/ 2mA/20mA/ 200mA	±(1.0%+3)	±(1.0%+3)	±(1.0%+3)	±(1.5%+4)
	10A	±(3.0%+5)	±(3.0%+5)	±(3.0%+5)	±(1.5%+3)
AC Current	200µA/ 2mA/20mA/ 200mA				±(1.5%+4)
	10A				±(1.5%+4)
Resistance	200Ω/2kΩ/ 20kΩ/200kΩ /2MΩ/20MΩ	±(0.8%+4)	±(0.8%+4)	±(0.8%+4)	±(0.8%+4)
Temperature (°C/°F)	-20~1000°C			±(2.0%+2)	±(3.0%+3)
	-4~1832°F			±(2.0%+4)	±(3.0%+6)

2.1 Features

Features	Item	MS 8233A	MS 8233B	MS 8233C	MS 8233E
Display	counts	2000	2000	2000	2000
Autorange					●
NCV	Non-contact Voltage Detection		●	●	●
Diode		3.0V	3.0V	3.0V	1.5V
Continuity		<60Ω	<60Ω	<60Ω	<70Ω
Data Hold		●	●	●	●
Display Backlight			●	●	●
MAX					●

3. FRONT PANEL

Reminder: The image shown here is indicative only. If there is inconsistency between the image and the actual product, the actual product shall govern.

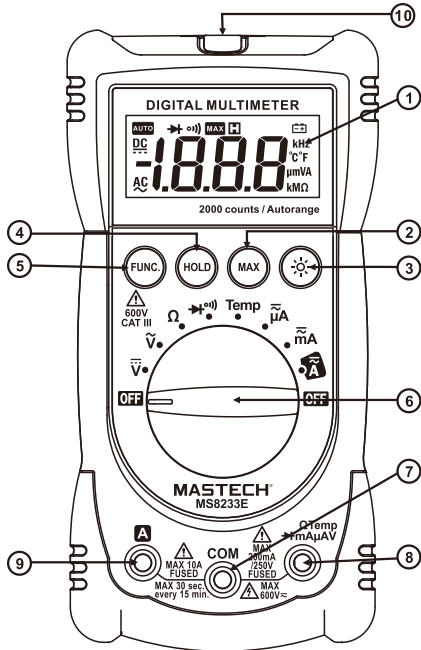

3.1 FRONT PANEL DESCRIPTION

- ① **Display**
3 1/2 digit, (2000 count) LCD.
- ② **“MAX” push button**
This key is act with trigger. Press this key once, the maximum value is holding (Will displays “MAX” symbol in the LCD). After pressing the key, A/D will keep working, and display value are always up dated and kept the maximum value.
NOTE: The actual gained value is not the peak value.
- ③ **“BACK LIGHT” push button**
This key is used control Backlight. When press and hold the key over 2 sec, will enable Backlight. Press the key again, the backlight will disable.
NOTE: MS8233B/C backlight is self-off after about 10 seconds. The backlight will on, push this button again.
- ④ **“HOLD” push button**
When this button is pushed, the display will keep the last reading and “H” symbol will appear on the LCD until pushing it again.
- ⑤ **“FUNC” push button**
This key is the function select key that acts with trigger. Use the key as switch of DC/AC current, Diode/ Continuity and °C/°F.
NOTE: Just MS8233E has this key.
- ⑥ **Rotary switch**
This switch is used to select functions and desired ranges as well as to turn on/off the meter.

- ⑦ **“COM” jack**
Plug in connector for black (negative) test lead.
- ⑧ **“VΩmA” jack**
Plug in connector for red (positive) test lead for voltage, resistance and current (except 10A) measurements.
- ⑨ **“10A” jack**
Plug in connector for red test lead for 10A measurement.
- ⑩ **red LED**
Non-contact voltage detection indicator.

3.2 GENERAL

Maximum voltage between input and the ground	CAT III 600V
Fuse protection	F1: FF 400mA H 600V F2: FF 10A H 600V
Power	9V battery, NEDA 1604 or 6F22
Display	LCD 2000 counts, updates 2-3/sec
Measuring method	Dual-slope integration A/D converter
Over range Indication	Only figure “1” on the display (MS8233E display “OL”)
Polarity indication	“-” displayed for negative polarity
Operating Environment	0°C to 40°C
Storage temperature	-10°C to 50°C
Low battery indication	“  ” appears on the display
Size	140mm×67mm×30mm
Weight	Approx.112g.

4. OPERATING INSTRUCTIONS

4.1 DC/AC voltage measurement

1. Connect the red test lead to the “**V.Ω.mA**” jack and the black lead to the “**COM**” jack.
2. Set rotary switch at desired DCV/ACV position. If the voltage to be measured is not known beforehand, set range switch at the highest range position and then reduce it until satisfactory resolution is obtained.
3. Connect test leads across the source or load being measured.
4. Read voltage value on the LCD display along with the polarity of the red lead connection



Warning

To avoid harms to you or damage to the meter from electric shock. Please do not attempt to measure voltage higher than DC/AC 600V although readings may be obtained. AC Frequency range: 40Hz to 400Hz. Response: Average responding, calibrated in rms of a sine wave.

4.2 DC/AC current measurement

Overload Protection: 400mA/600V fuse. 10A/600V fuse.

1. Connect the red test lead to the “**V.Ω.mA**” jack and the black test lead to “**COM**” jack. (For measurements between 200mA and 10A, remove red lead to “**10A**” jack.)
2. Set the rotary switch at desired DCA/ACA position.
3. Open the circuit in which the current is to be measured, and connect test leads in series with the circuit.
4. Read current value on LCD display along with the polarity of red lead connection.

4.3 Resistance measurement

1. Connect the red test lead to “**V.Ω.mA**” jack and black test lead to the “**COM**” jack. (The polarity of red lead is positive “+”.)
2. Set the rotary switch at desired “**Ω**” range position.
3. Connect test leads across the resistor to be measured and read LCD display.
4. If the resistance being measured is connected to a circuit, turn off power and discharge all capacitors before applying test probes.

4.4 Diode test

1. Connect the red test lead to “**V.Ω.mA**” jack and the black test lead to the “**COM**” jack (The polarity of red lead is positive “+”).
2. Set the rotary switch at “**▶**” position.
3. Connect the red test lead to the anode of the diode to be tested and the black test lead to the cathode of the diode. The approx. forward voltage drop of the diode will be displayed. If the connection is reversed, only figure “1” will be shown.

4.5 Audible continuity test

MS8233E use the “**FUNC**” key to enter to the continuity mode.

1. Connect red test lead to “**V.Ω.mA**”, black test lead to “**COM**”.
2. Set range switch to “**⦿**” position.
3. Connect test leads to two points of circuit to be tested. If continuity exists, built-in buzzer will sound.

4.6 Measuring temperature

1. If you use °C function, set the rotary switch at °C position. If you use °F function, set the rotary switch at °F Position. When shorted two test probe. The LCD display will show the current environment temperature.
2. Connect the red lead of “**K**” type thermocouple into the “**V.Ω.mA**” jack and the black lead of “**K**” type thermocouple into the “**COM**” jack.
3. Read temperature value on the LCD display.



Warning

To avoid electric shock, be sure the thermocouple has been removed before changing to another function measurement.

4.7 Non-contact voltage detection

When the meter head closed to the AC voltage field, the LED lighted the closed distance is about 30mm from the AC voltage field.



Warning

Even without LED indication, the voltage may still exist. Do not rely on non-contact voltage detector to determine the presence of voltage wire. Detection operation may be subject to socket design, insulation thickness and different type and other factors.

5. BATTERY & FUSE REPLACEMENT

If “” appears on display, it indicates that the battery should be replaced.

Fuse rarely need replacement and blow almost always as a result of operator's error.

To avoid electrical shock, Remove test leads before opening battery or fuse cover.

To prevent fire, Install quick acting fuse with amp / volt rating shown:

F1:FF 400mA H 600V F2:FF 10A H 600V

To replace fuse remove the 2 screws in the bottom of the case. To replace battery remove the 1 screws of the battery cover. Simply remove the old, and replace with a new one. Be careful to observe battery polarity.



Warning

Before attempting to open the case, always be sure that test leads have been disconnected from measurement circuits. Close case and tighten screws completely before using the meter to avoid electrical shock hazard.

5.1 Accessories

- | | |
|------------------------------------|------|
| 1. Operator's instruction manual | 1pcs |
| 2. Set of test leads | 1pcs |
| 3. Gift box | 1pcs |
| 4. 9 volt battery | 1pcs |
| 5. K-type temperature probe(P3400) | 1pcs |
| 6. Rubber case (Optional) | 1pcs |
- K-type temperature probe(P3400)Just provide for MS8233C and MS8233E.

